

eKinex

CONTROL YOUR LIVING SPACE

Application Manual



Control and display units *Touch&See* EK-EC2-TP and EK-EF2-TP

Contents

1.	Scope of the document.....	6
2.	Product description	7
3.	Switching, display and connection elements	8
4.	Configuration	9
4.1	Firmware upgrade.....	9
5.	Commissioning	11
6.	Device customization	12
7.	Function description.....	13
7.1	Local function description	13
7.2	Structure of interface pages	14
7.3	Graphic elements on interface pages.....	15
7.4	User interface	19
7.4.1	Zone chrono-thermostat	19
7.4.2	Calendar page swipe	22
7.4.3	Meteo station: maximum and minimum outside temperature.....	23
7.4.4	Multimedia station: equalizer and auto-off.....	23
7.4.5	Open windows display	24
7.4.6	Function setup	24
7.4.7	Device settings	27
7.5	Password-protected lock	28
7.6	Graphical themes.....	29
8.	General settings.....	30
8.1	General	30
8.2	Date and time	33
8.3	Internal sensors	36
8.3.1	Temperature sensor	36
8.3.2	Settings.....	36
8.4	Window contacts	38
8.5	Graphical pages	40
8.6	Display.....	41
9.	Pushbutton command pages.....	43
9.1	Graphical elements customization.....	43
9.1.1	Pages selection	43
9.1.2	Horizontal and vertical pushbuttons pairing	43
9.1.3	LED pushbuttons	43

9.1.4 Pushbutton texts and icons	44
9.2 Online operations.....	45
9.2.1 Pushbuttons pairing	45
9.2.2 Single or independent pushbuttons	45
9.2.3 Coupled pushbuttons.....	45
9.2.4 Cyclic sending.....	46
9.2.5 Lock function.....	46
9.3 Device settings	47
9.3.1 Pushbuttons configuration	47
9.3.2 Pushbutton X (independent mode).....	49
9.3.2.1 Pushbutton X: send values or sequences	49
9.3.2.2 Object X: send values or sequences	50
9.3.2.3 Pushbutton X: dimming.....	53
9.3.2.4 Pushbutton X: shutter or venetian blind.....	56
9.3.2.5 Pushbutton X: scene.....	58
9.3.2.6 Pushbutton X: lock function	60
9.3.3 Pushbutton X and next (coupled mode)	63
9.3.3.1 Switching.....	63
9.3.3.2 Dimming.....	64
9.3.3.3 Shutter or venetian blind.....	66
9.3.3.4 Lock function.....	68
9.3.4 LED pushbutton X and next.....	70
9.3.5 Texts and icons.....	73
10. Rocker configuration.....	77
10.1 Customization and online operation	77
10.1.1 Rocker use with independent functions, parallel and coupled pushbuttons.....	77
10.1.2 Led rockers	77
10.2 Device settings	78
10.2.1 Rockers configuration	78
10.2.2 Rocker xA/B (independent mode)	80
10.2.2.1 Rocker xA/B: send values or sequences.....	80
10.2.2.2 Object X: send values or sequences	81
10.2.2.3 Rocker xA/B: dimming	84
10.2.2.4 Rocker xA/B: shutter or venetian blind	86
10.2.2.5 Rocker xA/B: scene	88
10.2.2.6 Lock function.....	90
10.2.3 Rocker x, Functions A and B coupled	93

10.2.3.1	Switching.....	93
10.2.3.2	Dimming.....	94
10.2.3.3	Shutter or venetian blind.....	96
10.2.3.4	Lock function.....	98
10.2.4	LED Rocker x.....	100
11.	Zone ambient chronothermostat configuration	102
11.1	Online operations.....	102
11.1.1	External sensors	102
11.1.2	Applications	102
11.1.3	Control algorithms.....	103
11.1.3.1	<i>Two-point control with hysteresis</i>	103
11.1.3.2	<i>Continuous Proportional-Integral control</i>	104
11.1.3.3	<i>PWM-output Proportional-Integral control</i>	105
11.1.3.4	<i>Fan-coils with On / Off fan speed control</i>	106
11.1.3.5	<i>Fan-coil with continuous speed control</i>	107
11.1.3.6	<i>Control for auxiliary heating / cooling system</i>	107
11.1.4	Operating modes	108
11.1.5	Daily – weekly scheduler	109
11.1.6	Seasonal mode switching (Heating / Cooling).....	109
11.1.7	Window switch management.....	111
11.1.8	Presence detection	111
11.1.9	Scene management.....	113
11.1.10	Function activation via bus	113
11.2	Device settings	114
11.2.1	Configuration zone (X).....	114
11.2.2	Zone heating.....	119
11.2.2	Zone cooling	123
11.2.3	Zone fan.....	126
11.2.4	Zone presence detection	128
11.2.5	Zone scenes function.....	130
12.	Meteo page.....	132
12.1	Online operations.....	132
12.2	Device settings	132
13.	Multimedia page	135
13.1	Online operations.....	135
13.2	Device settings	136
14.	Service functions	138

14.1 Online operations.....	138
14.1.1 Timers.....	138
14.1.2 Presence simulation	138
14.1.3 Alarms.....	139
14.2 Device settings	141
14.2.1 Timers.....	141
14.2.2 Presence simulation	143
14.2.3 Alarms.....	144
15. Appendix.....	145
15.1 KNX communication objects summary.....	145
15.2 Pushbuttons custom symbols summary	162
15.3 System alarms summary	165
15.4 Technical characteristics	168
15.5 Warning.....	169
15.6 Other information	169

1. Scope of the document

This application manual describes application details for the ekinex® KNX “Touch&See” control and display unit, for EK-EC2-TP v.5.0 and EK-EF2-TP (with additional rockers) v.3.0 respectively.

The document is aimed at the system configurator as a description and reference of device features and ETS application programming. For installation, mechanical and electrical details of the device please refer to the technical description datasheet.

Application manual and ETS application programs are available for download at www.ekinex.com.

Document	Filename (## = version)	Version	Device revision	Latest update
Technical datasheet	STEKEC2TP_EN.pdf	EK-EC2-TP		
	STEKEF2TP_EN.pdf	EK-EF2-TP		
Application manual	MAEKECF2TP_EN.pdf	EK-EC2-TP EK-EF2-TP	2.0	12/2018
Application program	APEKEC2TP##.knxprod	EK-EC2-TP	5.0	11/2018
	APEKEF2TP##.knxprod	EK-EF2-TP	3.0	12/2018

You can access the most up-to-date version of the full documentation for the device using following QR codes:



EK-EC2-TP



EK-EF2-TP

2. Product description

The ekinex® Touch&See control and display unit is a wall-mount device for control and display of KNX bus functions with an integrated bus communication module.

Through the 3.5" touchscreen and the graphical user interface, the user can control KNX actuators and display information from KNX sensors and devices in an easy and intuitive way.

The device also has the functions of a complete chrono-thermostat based on the ambient temperature sensing of other KNX devices.

In EK-EF2-TP version 2 additional rockers are also available.

The device requires, besides the connection to the KNX bus, an auxiliary SELV 30VDC power supply, usually available in common double-output KNX power supply units.



For further technical information, please also refer to the product datasheets STEKEA2TP_EN.pdf and STEKEF2TP_EN.pdf available on the ekinex website www.ekinex.com.

3. Switching, display and connection elements

The device is equipped on the backside with:

- a programming pushbutton and a programming LED
- plug terminals for the KNX bus line connection
- plug terminals for the connection of the auxiliary power supply
- a slot for a micro SD card

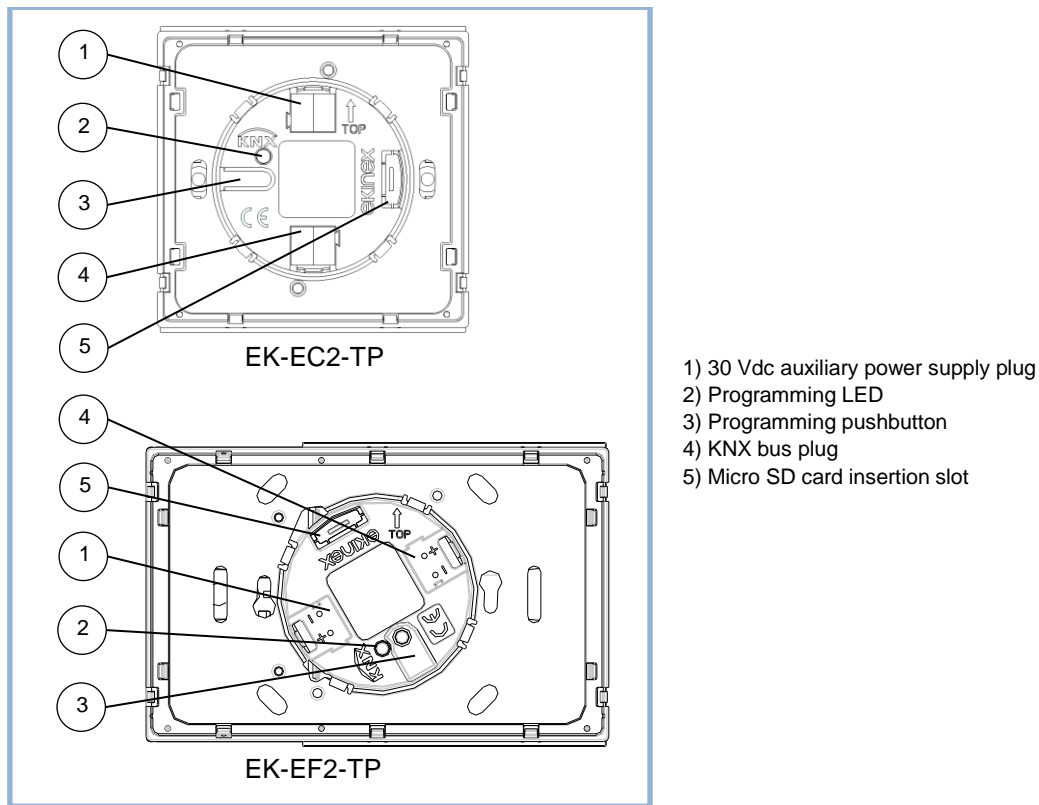

Picture 1

On the front side, the central part of the device surface is the touch-screen display; in the upper left corner, a sensor for ambient light is placed.

4. Configuration

The exact functionality of the device depends on the software settings.

In order to configure and commission the device, the ETS4 tool (or later releases) is required together with the proper ekinex® application programs APEKEC2TP.knxprod and APEKEF2TP.knxprod. These programs can be downloaded from the ekinex® website www.ekinex.com, either as a single file or as part of the complete database of ekinex® products. The ETS application program allows the configuration of all working parameters for the device.

The device-specific application program has to be loaded into ETS or, as alternative, the whole ekinex® product database can be loaded; at this point, all the instances of the selected device type can be added to the project.

For every single device, ETS allows to set the operating parameters individually for each of the device functions as described in detail in the following chapters.

The configuration can, and usually will, be performed completely offline; the actual transfer of the programmed configuration to the device takes place in commissioning.

Product code	EAN	Version	ETS application software (## = release)	Communication objects (max nr.)	Group addresses (max nr.)
EK-EC2-TP	8018417181078	Without rockers	APEKEC2TP##.knxprod	1088	1088
EK-EF2-TP	8018417181108	With rockers	APEKEF2TP##.knxprod	1088	1088



Configuration and commissioning of KNX devices require specialized skills. To acquire these skills, you should attend training courses at a training center certified by KNX.

For further information: www.knx.org

4.1 Firmware upgrade

If a new firmware for the device should be made available by ekinex, either to add new features or to correct possible errors in the present firmware, the device allows the system integrator to perform a firmware upgrade through a Micro SD card.



The firmware upgrade should only be performed by a qualified KNX technician.

After the upgrade, the device loses its configuration and therefore the previous configuration needs to be reprogrammed through the ETS tool. Before attempting a firmware upgrade, make sure that you have the latest KNX project at hand with a working configuration for the device.

The procedure is as follows:

- remove all power supplies from the device, i.e. both the red-black and the white-yellow connector plugs;
- download the file for the most recent firmware upgrade from the ekinex website;
- format a Micro SD card, of size of up to 2GB, with a FAT32 format;
- from a PC, using an external USB Micro SD card reader (if the PC should not be equipped with an integrated reader), unpack the downloaded file and copy the two extracted files on the root of the Micro SD card;
- insert the card in the slot on the back side of the Touch&See;

- insert only the auxiliary power supply connector (white-yellow);
- look at the display; at the end of the process, a message “*Firmware upload to version x.y OK. Remove SD card*” should appear;
- remove the Micro SD card and the aux power supply connector plug; re-insert the connector plug and verify that the device starts correctly.

Once the device has correctly restarted, the red-black KNX bus connector can be reinserted and the device functions can be reprogrammed (with the same configuration as before) through the ETS tool.

In order to verify which firmware release is currently loaded on the device, enter the *Settings* option page and select *Info*. In the *Info* page the physical address currently set on the device is also displayed; should the device be in programming mode (reset pushbutton on the backside pressed), a red graphic LED will be displayed on the page, indicating the active programming status.

5. Commissioning

After the device has been configured within the ETS project according to user requirements, the commissioning of the device requires the following activities:

- electrically connect the device, as described in the product datasheet, to the bus line on the final network or through a purposely setup network for programming;
- apply power to the bus;
- switch the device operation to programming mode by pressing the programming pushbutton located on the back side of the housing (see Picture 1). In this mode of operation, the programming LED is turned on steady;
- upload the configuration (including the physical address) to the device with the ETS program.

At the end of the upload, the operation of the device automatically returns to normal mode; in this mode the programming LED is turned off. Now the device is programmed and ready for use on the bus.



In ETS software, it is possible to delete the application currently installed on the device EK-EC2-TP or EK-EF2-TP by means of the functions *Delete Application* or *Delete Applications and Physical Address*.

Warning: at the end of this operation, it will not be possible to display and interact with any graphic page on the touchscreen. In order to restore the user interface, a new configuration download is necessary, by means of the ETS function *Download All*.

6. Device customization

The graphics and images used for the splash screen and the pushbuttons are preloaded on the device, but they can be replaced with customized images. These customized images can be copied on a Micro SD card from a PC and then loaded on the *Touch&See* by placing the SD card in the slot on the back of the device.

The images have to be in the .PNG format (*Portable Network Graphics*) with the names and maximum sizes described in the table below; images having different parameters are not loaded.

The procedure to load customized images into the device is as follows:

- remove all power supplies from the device, i.e. both the red-black and the white-yellow connector plugs;
- format a Micro SD card, of size of up to 2GB, with a FAT32 format;
- from a PC, using an external USB Micro SD card reader (if the PC should not be equipped with an integrated reader), copy the files of the desired images on the root of the Micro SD card;
- insert the card in the slot on the back side of the *Touch&See*;
- insert only the auxiliary power supply connector (white-yellow);
- look at the display; at the end of the process, a message “*Images upload OK. Remove SD card*” should appear;
- remove the Micro SD card and the aux power supply connector plug; re-insert the connector plug and verify that the device starts correctly;
- re-insert the KNX bus connector plug.

Once the customized images have been loaded, they have yet to be selected in order to appear at their respective places.

Image destination	Dimension in pixels	Max. size in KBytes	File name
Background	320 x 240	128	backimg.png
Pushbutton icon	111 x 111	8	Icon#.png (# = 01...08)

Background image

The default background image for the splash screen carries the ekinex® brand logo. In order to replace it, after the desired image has been loaded as described above, follow the steps below:

- open the device application program in ETS;
- under the menu *General*, item *Background image*, select the option *Other (copied from SD card)*.

For further details about screen settings, please refer to the chapter describing general display settings.

Pushbutton icons

The default image for a pushbutton is a blank image; the system integrator can then select either one of the preloaded icons or one of the customized icons loaded as described above.

To change the image assigned to a pushbutton, follow the steps below:

- Open the device project in ETS4 (or later releases);
- make sure that the desired pushbutton page is enabled by setting the option *Page configuration / Pushbuttons 1,2,3 and 4 – A* (or B, C, D, E, F, G, H) to *enable* them;
- under the menu item *Pushbuttons 1,2,3 and 4 – A* (or B, C, D, E, F, G, H) / *Text and Icons*, for each item *Icon <x> pushbutton <y>* choose the desired custom icon between *Icon01...Icon08*.

7. Function description

7.1 Local function description

Bus failure and power-up behavior

The behavior on bus failure is programmable with ETS. The device is equipped with two capacitors allowing the function parameters to be saved in case of bus and auxiliary voltage failure.

Device features

The Touch&See control and display unit is a multi-functional room controller that allows to interact from a single location with many KNX sensors, actuators and devices for building automation. The device offers the following configurable functions:

- up to 8 ambient temperature chrono-thermostats with individual clock scheduling, designed for controlling radiators, radiating systems and fan coil units;
- ON / OFF control for single or group actuators and transmission of timed sequences of up to 8 Communication Objects of different types;
- dimming control of lighting devices;
- control of shutters and venetian blinds;
- event programmer (up to 10 scheduled events);
- display of date and time either from the internal Real-time Clock or from other KNX devices;
- display of meteorological values (temperature, wind speed, rain detection, humidity, light intensity...) from a KNX sensor or meteo station;
- display of alarm messages, both generated inside the device (sensor failure, missing value reception etc.) or outside (max. 20 messages);
- scenes recall and memorization;
- simulation of presence (with max. 16 communication objects);
- sending of values over the bus (temperature, brightness, etc.);
- parameter modification lock with password protection;
- temporary lock function for screen cleaning.

Interface pages

The user interface of the Touch&See is made of several main pages, displayed in sequence or directly accessed, that can be enabled or disabled according to the functions of interest.

The following pages are available:

- chrono-thermostat;
- load switching (8 pages);
- calendar;
- meteo;
- multimedia;
- service features (timers, alarms).

User interface customization

The graphic elements like background images or command pushbutton icons can be chosen during parametrization from an internal image library; additionally, custom images can be loaded into the device using a Micro SD card.

7.2 Structure of interface pages

The following picture shows the navigation structure for the interface pages of the Touch&See unit. All available pages are shown; some of these pages can be disabled if the respective functions are not required, either for the lack of corresponding devices on the KNX network or for the limitation of the device features according to the intended application.

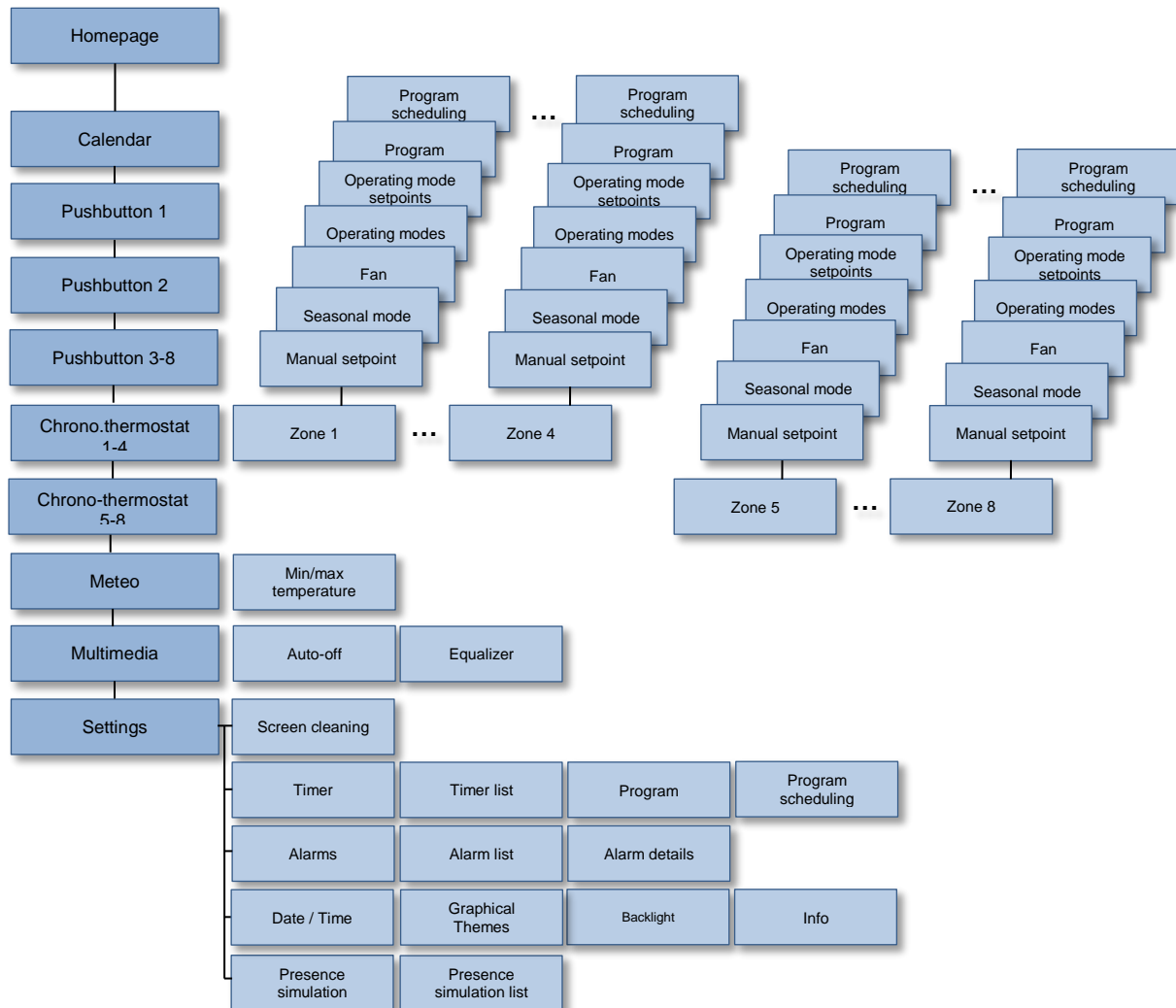

i The actions which are actually effective on each page may depend on the availability of devices equipped with corresponding sensors or actuators on the KNX network.
In the present listing, a complete set of pages is shown; the pages which are not enabled in the device configuration will not be displayed.

A short press (i.e. tapping with a finger on a screen element) is used to select icons, menu entries or option values; a long press (i.e. keeping the finger on the element for a longer time) activates the sub-pages, shown in lighter color in the picture, for settings and parameter display.

For the pushbutton pages (*Pushbutton 1*, *Pushbutton 2* and *Pushbutton 3-8*), depending on the selected configuration, a short or long press on the virtual pushbuttons on the screen causes different behaviors and different telegrams to be sent on the KNX bus. For instance, the short and long press have particular meanings when the pushbuttons are configured for the control of dimmers or blind / shutter actuators.

As a general rule, in the subpages for settings, when an entry is selected with a short press, the (+) and (-) buttons change the activation state or the value of the corresponding parameter. By pressing the (OK) button, the changes are confirmed and saved in memory, while pressing the back arrow key (←) returns to the previous page canceling all changes.



7.3 Graphic elements on interface pages

Side column

The side column appears in all main pages.

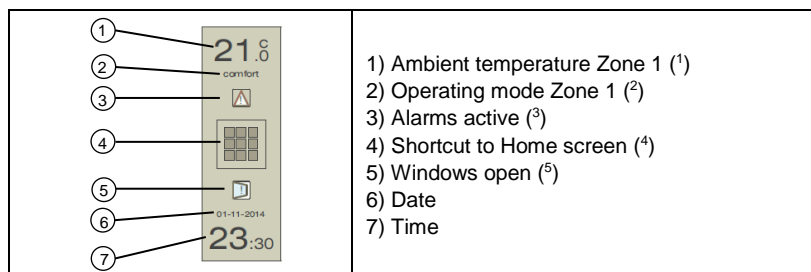

(1) The side column displays the ambient temperature of Zone1, measured as the average of up to 4 sensors. This information is only shown if the Chrono-thermostat function has been enabled. The value of external temperature is shown in the Meteo screen, if the Meteo page is configured as active.

- (2) The operating mode of Zone 1 (*comfort, standby, economy or protection*) flashes when a forcing condition is activated by from a supervisor device or presence detection. This information is only shown if the Chrono-thermostat function has been enabled.
- (3) The *Alarms* icon indicates the presence of one or more alarms: a log press on the icon takes to the alarm list display page.
- (4) A short press on the central icon takes to the “*Home*” menu page, where all other pages can be accessed directly.
- (5) The *Open windows* icon, if shown, shows that a window or door contact – associated through a communication object – is active, therefore the corresponding window / door is open; a long press on the icon takes to the display page that shows which one of the max. 4 available contacts is open.

Home menu page

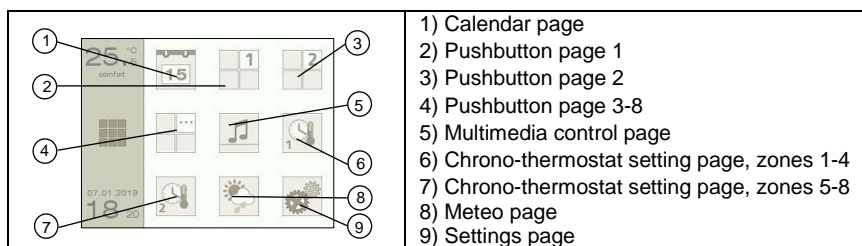

Pushbutton pages

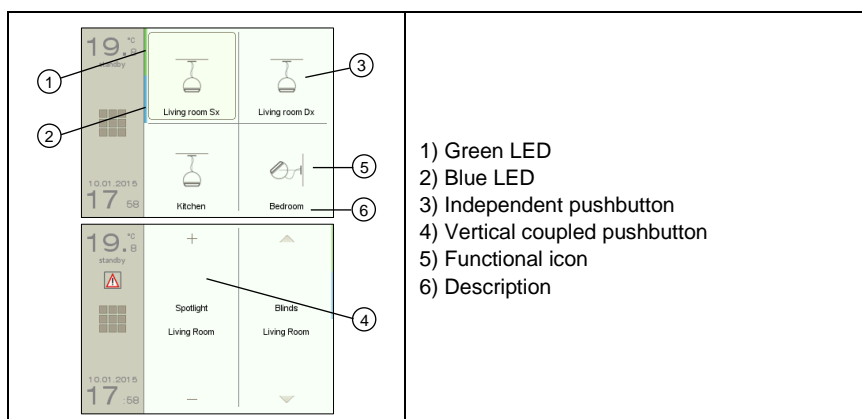

The pushbutton pages are configurable in number (1 up to 8 pages), in pushbutton position and in graphic and textual elements. The action performed by the pushbuttons depend on the automation function suitable for the building, such as control of lighting devices, shutters, venetian blinds or scene activation.

A short or long press of the pushbutton can trigger different actions. In the picture above, a short press in the upper side of the vertical pushbutton *Living Room Shutters* causes the shutter to open partially, while a long press will open the shutter completely. How long the user has to hold the pushbutton in order for the press to be recognized as “long” is a parameter that can be evaluated together with the system integrator during commissioning.

Chrono-thermostat page

	<ol style="list-style-type: none"> 1) Zone 1 2) Zone 2 3) Zone 3 4) Zone 4 (in the picture Zone 4 is not configured, thus it is not visible) 5) Zone 1 ambient temperature and operating mode on the side column 6) Indication of open windows in the current zone (darker icon) 7) Indication of open window in all zones (1)
--	---

(1) A short press takes to the page indicating which window is open (4 available contacts for each of the 8 zones). The icon on the sidebar column is visible only if the window contacts are configured for at least 1 zone and if at least one window is open.

Zone page

	<ol style="list-style-type: none"> 1) Description of the zone 2) Actual setpoint for ambient temperature 3) Ambient relative humidity (%) 4) Heating / cooling mode (1) 5) Fan status indication (2) 6) Operating mode indication (3) 7) Indicator for program scheduling active (4) 8) Pushbutton "Increment Temperature Setpoint" (+) 9) CO₂ concentration in the zone (ppm, parts per million) (2) 10) Pushbutton "Decrement Temperature Setpoint" (-) 		
<p>(1) The icon indicating current seasonal mode is displayed inside a circle when the temperature controller "demands" for energy. A short press on the icon takes to the interface page for seasonal mode switching. If the device is configured to automatically switch between heating and cooling mode, the for current seasonal mode switching will not be displayed.</p>			
	Heating mode		Cooling mode
<p>(2) A short press on the icon area takes to the interface page for fans speed setting.</p>			
	Fan not configured		Fan switched off
	Fan forced in manual mode		Fan in automatic mode
<p>(3) The icon represents the operating mode that can be forced both manually or by the program currently active on the zone. If current temperature set point is modified, the "operating mode: manual" icon "M" will be shown.</p>			
	Operating mode: Comfort		Operating mode: Standby
	Operating mode: Economy		Operating mode: Building protection
	Operating mode: manual		
<p>(4) The icon with bright colors indicates that a program scheduling is active on the zone.</p>			
	Program scheduling active		Program scheduling not active (clock in hazy color)
The colored stripes around the CO ₂ concentration value show an indication of the ambient air quality, according to a scale defined by EN 13779 european regulation. Low CO ₂ concentration means high air quality, while a value higher than 1000-1200 [ppm] means poor air quality.			
	High level (blue)		Average level (yellow)
	Medium level (green)		Poor level (red)

Multimedia page

	<ol style="list-style-type: none"> 1) Previous track (short press), rewind (long press) 2) Shortcut to Home screen 3) Lower volume 4) Mute 5) Sleeping (auto-off) mode (1) 6) Play / stop 7) Next track (short press), fast forward (long press) 8) Raise volume 9) Equalizer (1) 10) Off 11) Title of current track
<p>(1) The Auto-off and Equalizer icons take to the respective settings pages, which are enabled according to the configuration in the ETS application program.</p>	

Meteo page

	<ol style="list-style-type: none"> 1) Outside temperature 2) Indoor ambient temperature Zone 1 3) Shortcut to Home screen 4) Indicator of current general meteo condition 5) Atmospheric pressure [bar] 6) Trend for outside temperature (arrow pointing up or down) 7) Relative humidity [%] 8) Ambient brightness [lux] 9) Wind speed [km / h] or [m / s] 10) Trend for atmospheric pressure (arrow pointing up or down)
<p>The graphic indicator icon for general meteo condition combines the information from the outdoor light, rain and temperature sensor The possible states that are represented are the following:</p>	
	Day - Clear
	Day - Rain
	Day - Snow
	Night - Clear
	Night - Rain
	Night - Snow

7.4 User interface

7.4.1 Zone chrono-thermostat

Temperature set point

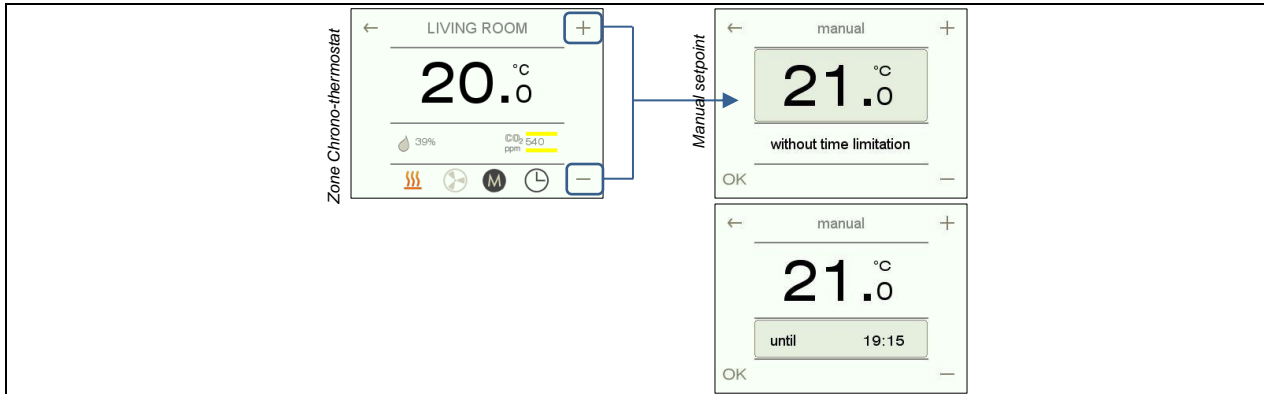

To access the *Zone Chrono-thermostat* page: in the *Home* page, select with a short press the zones icon, then select the desired zone to modify the set point temperature. A short press on (+) or (-) takes to the *Manual setpoint* subpage.

A short press on (+) or (-) increases / decreases the setpoint value by 0.5°C: as in all setting pages, a short press on (OK) confirms the change and saves the new set point value; a short press on (←) takes back to the previous page without saving any change.

Set point temperature can be retained by the chrono-thermostat without any clock limitations (default), or for a limited time interval; at the end of this time interval the previous set point value (forced by the current Operating Mode or by the Chrono-program) is restored.

In order to set a limited time interval to hold the new set point, select the “end of forcing” field, then select it again to switch to temporary mode: a short press on (+) or (-) increases / decreases the end of forcing time by 15 min steps, for a maximum of 24 hours starting from the current time.

Going back to *Zone Chrono-thermostat* page, if the changes are not confirmed with (OK), the manual mode will be indicated by the “Operating Mode: Manual” icon.

“Operating Mode: Manual” is not retained in case of power supply failure. To perform a permanent change of the temperature set point, switching off the current operating mode or activating a program scheduling is recommended.

Operating mode

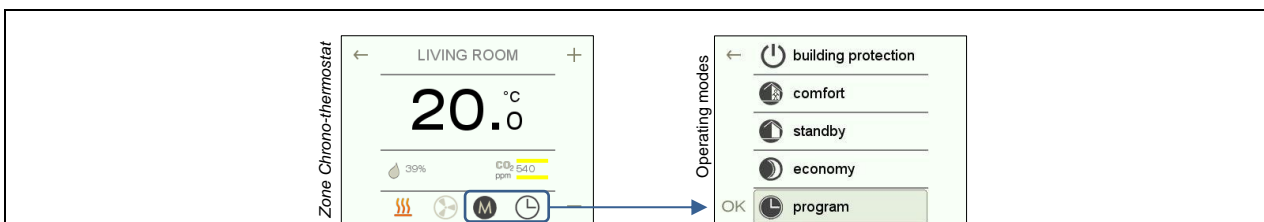

To access the *Zone Chrono-thermostat* page: in the *Home* page, select with a short press the zones icon, then select the desired zone to change the current operating mode. A short press on the area including

both the operating mode icon and the program scheduling indication icon takes to the *Operating Modes* subpage.

When the subpage opens, the current operating mode is displayed with the selected field highlighted; in this case, a short press on the desired operating mode and a short press on (OK) will confirm the setting, while a short press on (⇐) will cancel and return to the previous page without saving any change.

By selecting the operating modes *comfort*, *standby*, *economy* or *building protection*, the programmed temperature set points will be automatically set: these values will be retained permanently until the next change. Otherwise, by selecting *Program* mode an attenuation will be activated on the zone, based on the daily profile programmed for each day of the week.

Fans speed

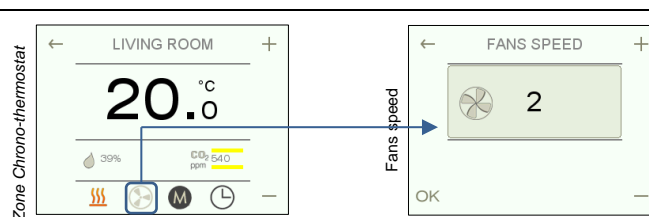

To access the *Zone Chrono-thermostat* page: in the *Home* page, select with a short press the zones icon, then select the desired zone to modify the current fans speed. A short press on the fan icon takes to the *Fans speed* subpage: if no fans are configured, the icon is replaced by an empty circle.

When the subpage opens, the current fan speed is displayed. A short press on (+) or (-) will set a new fan speed for the current zone: by selecting the Automatic option (A), speed is controlled automatically by the chrono-thermostat, based on actual heating or cooling demand. As in all setting pages, a short press on (OK) confirms the change and saves the new setting; a short press on (⇐) takes back to the previous page without saving any change.

Seasonal mode switching (Heating / cooling)

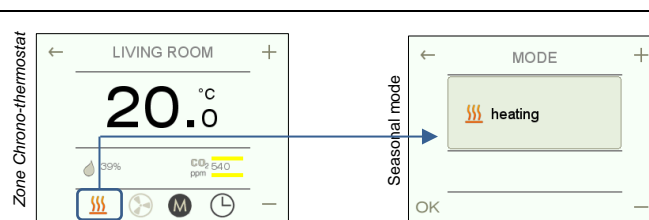

To access the *Zone Chrono-thermostat* page: in the *Home* page, select with a short press the zones icon, then select the desired zone to modify the current heating / cooling mode. A short press on the fan icon takes to the *Seasonal mode* subpage.

When the subpage opens, the current seasonal mode is displayed. A short press on (+) or (-) will set a new seasonal mode for the current zone. As in all setting pages, a short press on (OK) confirms the modification and saves the new setting; a short press on (⇐) takes back to the previous page without saving any change.



If the device is configured to automatically switch between heating and cooling mode, or the device is not meant to function in all seasons, the page for seasonal mode switching will not be displayed.

Program scheduling

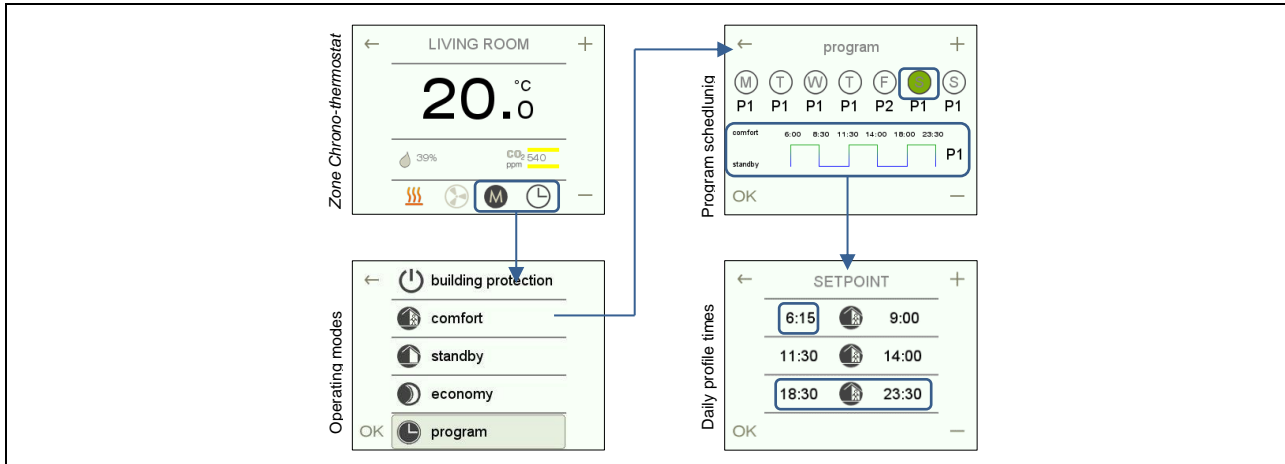

To access the *Zone Chrono-thermostat* page, from ETS enable the *Internal/external chrono function* parameter for the selected zone.

In the *Home* page, select with a short press the zones icon, then select the desired zone to modify its current program scheduling. A short press on the area including both the operating mode icon and the program scheduling indication icon takes to the *Operating Mode* subpage. From here, select the *Program* field with a long press to access the *Program Scheduling* subpage.

Program scheduling contains up to 7 selectable hourly programs (from P1 to P7), one for each day of the week. Each hourly profile contains a maximum of 3 comfort-mode periods, each one with a start time and a comfort end time.

In the *Program Scheduling* subpage, it is possible to connect a different hourly profile to each day of the week: with a short press on the day of the week, the corresponding day icon becomes green; with (+) and (-) a different hourly profile (from P1 to P7) is assigned. Always remember to press (OK) in order to save the new assignment.

In order to modify the profile times, starting from the *Program Scheduling* subpage, select with a short press the graphic profile showing the daily events and access the *Daily Profile Times* subpage. Selecting each field (at first, when it is not programmed yet, it will show -:-), a short press on (+) and (-) increases / decreases the hour by 15 min steps. After each setting or at the end of all fields settings, short press on (OK) to save changes.

To delete a whole comfort period, select the whole line by pressing centrally on the comfort icon: a short press on the bottom side, on the DELETE button, will delete the whole period.

A coherence control inside the device automatically deletes those events where the end time is prior to the start time. The 3 comfort periods do not necessarily need to be configured in chronological order, the device itself will ordinate them in a coherent way.

Operating mode setpoints change

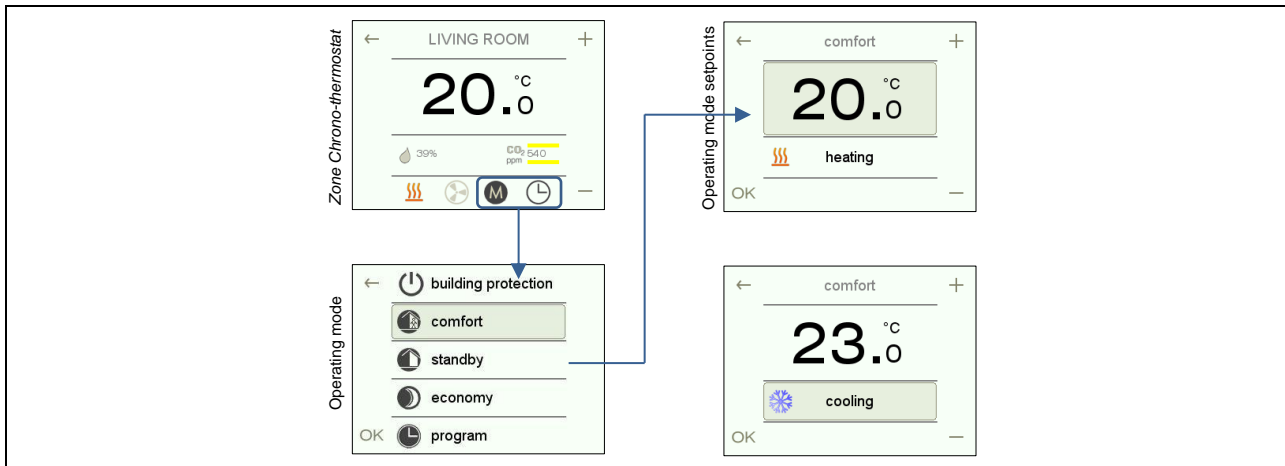

To access the *Zone Chrono-thermostat* page: in the *Home* page, select with a short press the zones icon, then select the desired zone to modify the current operating mode setpoints. A short press on the area including both the operating mode icon and the program scheduling indication icon takes to the *Operating Mode* subpage. From here, select the field (*comfort*, *standby* or *economy*) with a long press to access the *Operating Mode Setpoints* subpage.

A short press on (+) or (-) increases / decreases the setpoint value by 0.5°C. The displayed values refer to the current season operating mode, which is indicated in the field below. To modify the setpoint related to the next season, select with a short press the field indicating the season, press (+) or (-) to display the value related to the next season, then select once again the numerical field to modify it. A short press on (OK) confirms the change and saves the new setpoint values; a short press on (←) takes back to the previous page without saving any change.

Building protection setpoints in both seasons are not accessible to the user, as they are critical for the building components protection. Changing these parameters require a complete device reconfiguration and the intervention of qualified personnel.

7.4.2 Calendar page swipe

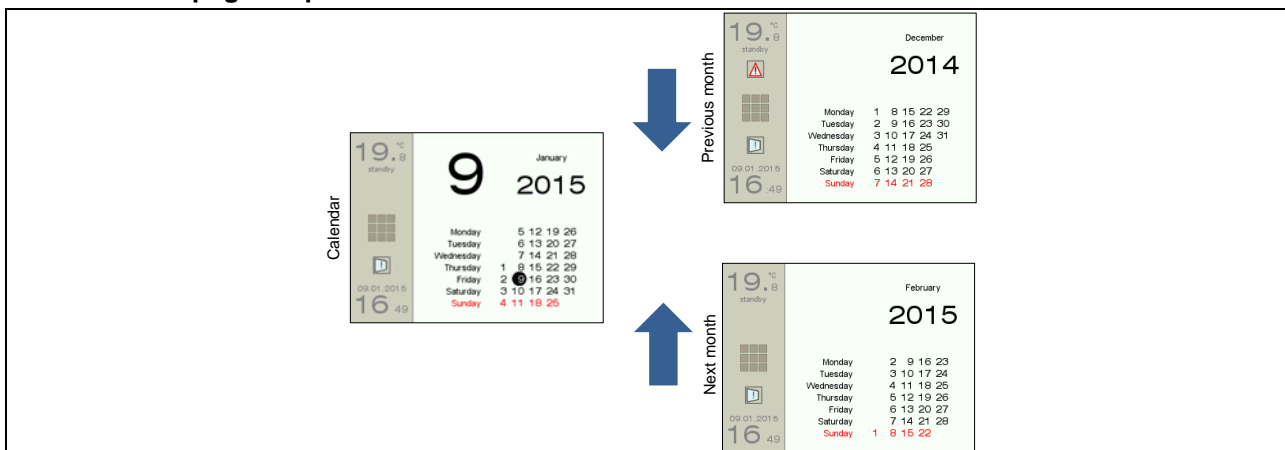

From the *Home* page, select the *Calendar* page to display the calendar of current month. Current day is highlighted with a black circle.

In order to scroll through the next months, the gesture to perform is a swipe from bottom upwards on the touchscreen.

7.4.3 Meteo station: maximum and minimum outside temperature

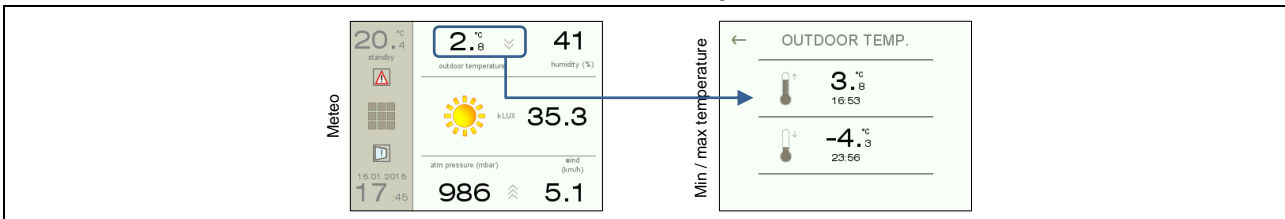

when the *Meteo* page is active, outside temperature and atmospheric pressure values display a trend indication on their side (arrows pointing up or down) which appears after 3 hours from the device power-up: this time is necessary to collect enough informations to evaluate trends. Direction and number of overlapping arrows (up to 3) supply informations about direction and intensity of the physical values gradients.

A short press on the outside temperature field takes to the page where maximum and minimum temperatures measured during the current day (from 00:00 to 23:59) are displayed.

7.4.4 Multimedia station: equalizer and auto-off

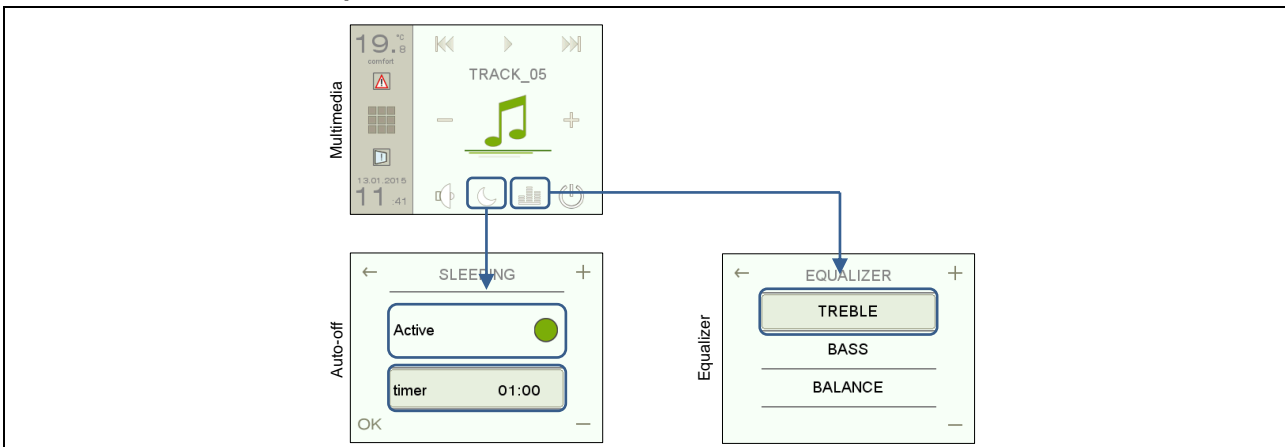

In order to setup the auto-off function of sound playback, select with a short press the *Sleeping* icon on the *Multimedia* page. Select the *Active* field and press (+) to activate (green circle) or (-) to deactivate (empty circle) the auto-off function. Select with a short press the *Time* field and press the (+) or (-) to increase / decrease the auto-off time delay by 15 min steps.

In order to setup an equalization filter, select with a short press the *Equalizer* icon. With a short press on each field and through (+) and (-) it is possible to either amplify or attenuate the selected frequency band (treble and bass) or balance the volume (balance function).

As in all setting pages, a short press on (OK) confirms the modification and saves the new setting; a short press on (←) takes back to the previous page without saving any change.

7.4.5 Open windows display

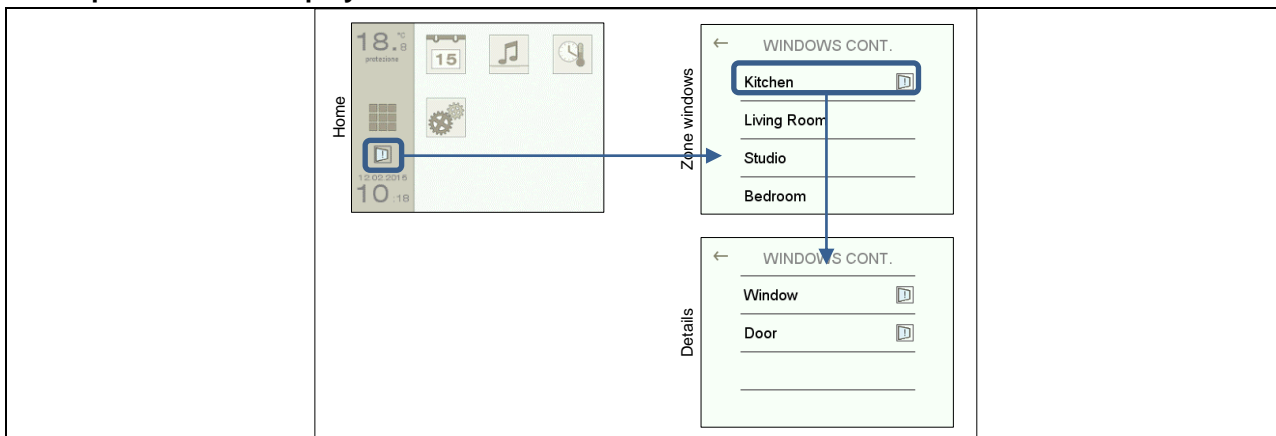

From the *Home* page, select in the side column the open window icon to access the *Zone Windows* page. The open window icon is visible when at least one window of the building is open. A short press on the zone of interest takes to the *Details* subpage, where it is possible to verify each window status for the selected zone.

It is possible to configure up to 4 window contacts for each of the 4 zones. The open window status can be simply displayed or integrated within the zone chrono-thermostat management by recalling the building protection operating mode with energy saving function.

If the open window status is integrated within the zone chrono-thermostat management, the zone with at least one window open will show the building protection operating mode icon blinking.

7.4.6 Function setup

Screen lock for cleaning

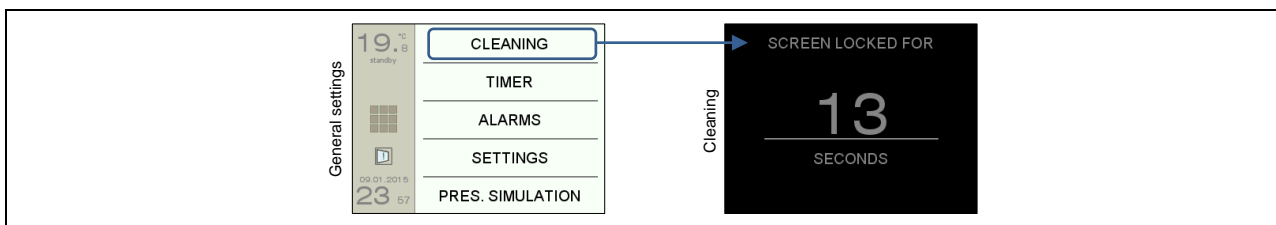

From the *Home* page, select the *General settings* page, then select *Cleaning*.

Activating the *Cleaning* page during screen cleaning avoids undesired actions and commands for a fixed time interval (30 seconds).

Timer Activation

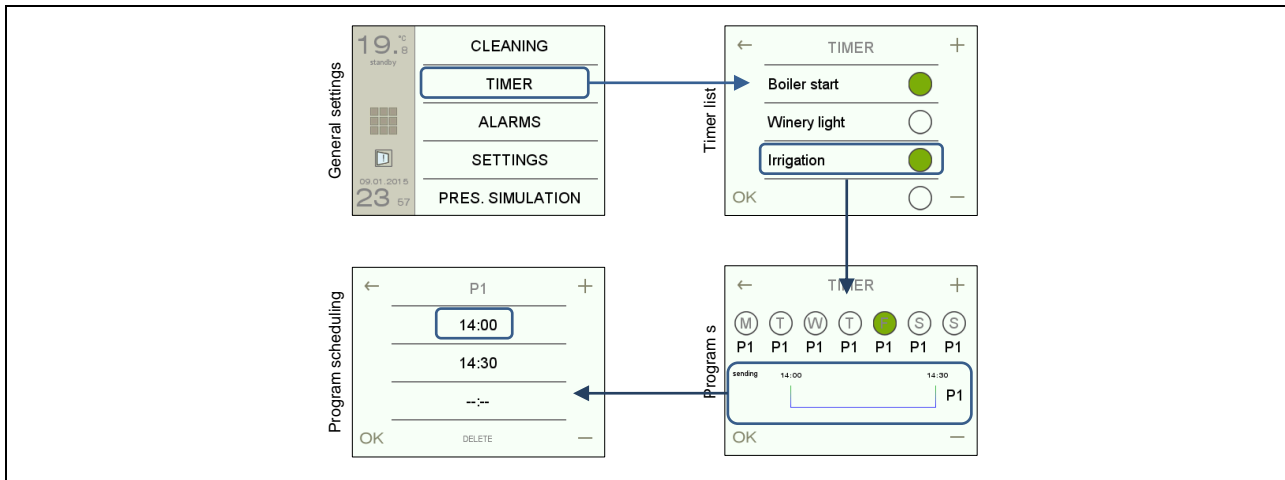

From the *Home* page, select the *General settings* page, then select **TIMER** to access the *Timer list* subpage. The device can support up to 10 timers for building automation.

To activate / deactivate a timer, select one element from the list, short press on (+) or (-) and confirm with (OK); a long press on the selected element takes to the *Programs* subpage.

In the *Programs* subpage, short press on the day of the week to select it (green full circle): a short press on (+) or (-) changes the assigned program from P1 to P7.

A selection of the area showing the activation profile takes to the *Program Scheduling* subpage, where up to 3 daily activation times for each assigned program can be configured: after selecting the desired time field, a short press on (+) or (-) will increase / decrease activation time value by 15 min steps.

A short press on **CANCEL** pushbutton deletes the selected activation time.

As in all setting pages, a short press on (OK) confirms the modification and saves the new setting; a short press on (←) takes back to the previous page without saving any change.

Alarms visualization

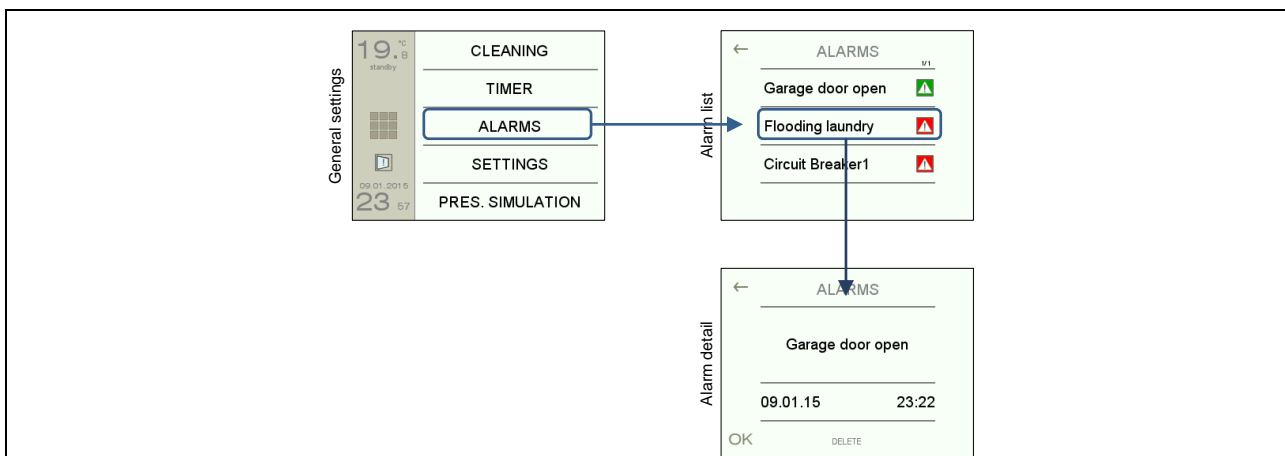









From the *Home* page, select the *General settings* page, then select **ALARMS** to access the *Alarm list* subpage. Alternatively, it is possible to use the Alarm icon shortcut, visible on the side column only in case of active alarms: please refer to the chapter related to the graphic elements for further information.

In the *Alarm list* page, swiping upwards or downwards scrolls through the alarms: the list can contain historical data of the latest 40 issued alarms. A short press on a single alarm takes to the *Alarm Detail* subpage.

In the *Alarm Detail* subpage, a short press on CANCEL removes the alarm from the list; a short press on (OK) marks the alarm as acknowledged (i.e., silenced) by the user. A short press on (⇐) takes to the previous page without any acknowledge.

Each alarm in the list is displayed with a short descriptive text and with an icon summarizing the source of the alarm (external or internally generated for timeout or sensor failure), the activity state (still active or ceased) and the acknowledgement by the user. Externally generated alarms are configured during commissioning, so please refer to the system integrator for a list of managed alarms. Internally generated alarms refer to specific device failures as well as failures related to the components of the automation system: for an exhaustive list of the description codes, please refer to the table in the Appendix.

	Externally generated alarm, active and not acknowledged
	Externally generated alarm, ceased and not acknowledged
	Externally generated alarm, active and acknowledged
	Externally generated alarm, ceased and acknowledged
	Internally generated alarm, active and not acknowledged
	Internally generated alarm, ceased and not acknowledged
	Internally generated alarm, active and acknowledged
	Internally generated alarm, ceased and acknowledged

Presence simulation

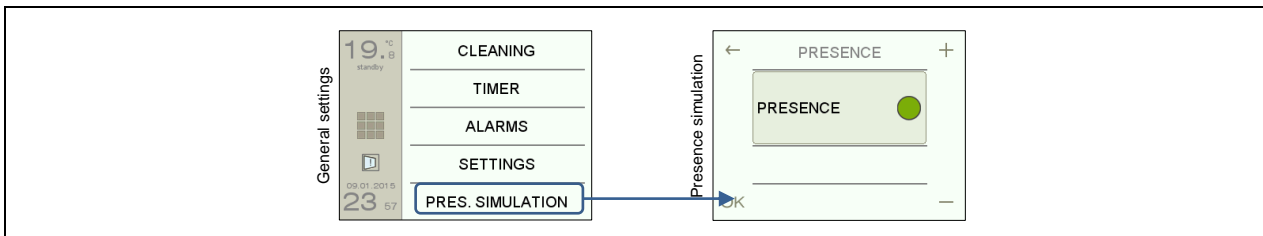

Presence simulation is a feature that automatically carries out ordinary daily operations like switching lights or raising and lowering blinds, according to a pre-recorded sequence, when the building is not occupied. When the *Presence simulation* is activated, the system starts reproducing the changes of state for the involved objects in real time.

The activation status is retained even after a voltage failure.

From the *Home* page, select the *General settings* page, then select PRES.SIMULATION. From the *Active Presence simulation* subpage, a short press on (+) activates presence simulation (green circle), a short press on (-) deactivates it (empty circle).

A short press on (OK) confirms and starts the function; a short press on (⇐) cancels the operation and takes back to the previous page without starting the function.

7.4.7 Device settings

Date / time

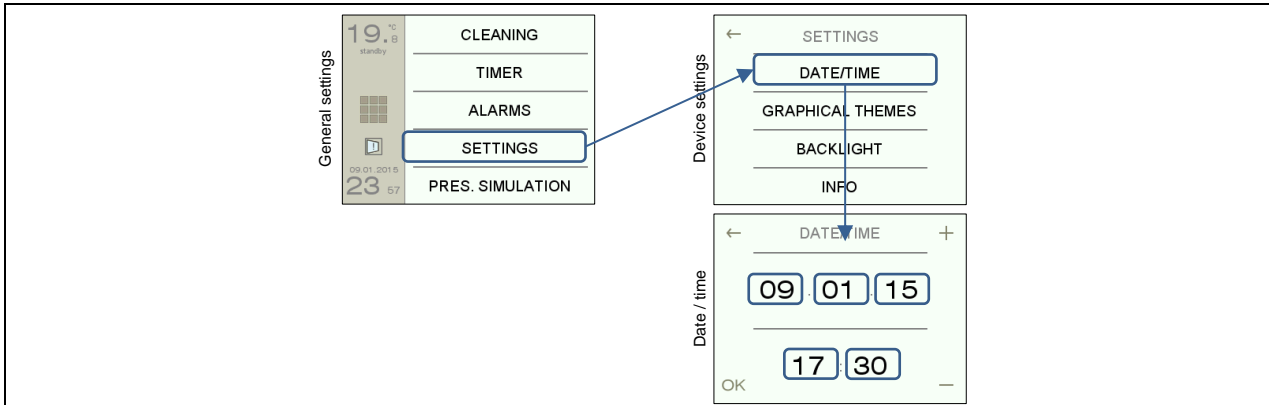

From the *Home* page, select the *General settings* page, then select **SETTINGS** and **DATE / TIME**.

In *Date / time* subpage, select each numeric field with a short press: press (+) or (-) to select the desired value. Confirm with (OK) after each modification or after all modification to activate the new date / time settings or cancel with (⇐).

The *Date / Time* page is accessible only if the device has been configured to synchronize with the internal clock. Automatic daylight saving time switching is a parameter that needs to be configured by the system integrator during commissioning.

Backlight

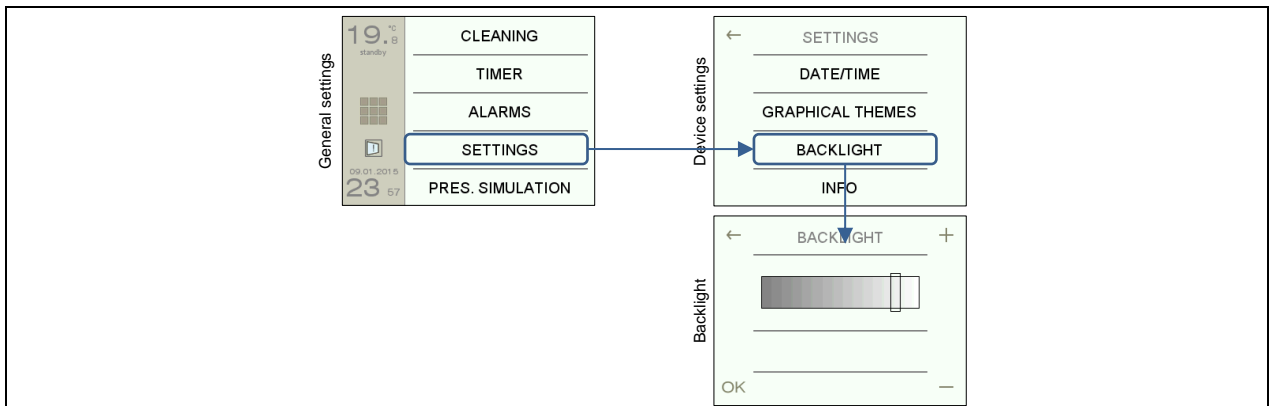

From the *Home* page, select the *General settings* page, then select **SETTINGS** and **BACKLIGHT** to access *Backlight* subpage.

A short press on (+) or (-) changes the desired backlight intensity. Press (OK) to confirm or cancel with (⇐).

Info Window

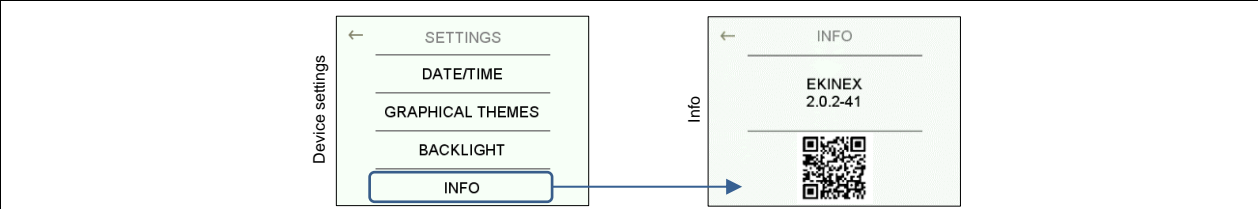

From the *Home* page, select the *General settings* page, then select SETTINGS and INFO. The *Info* subpage displays the current firmware version. It is also possible, with the QR code and a mobile device, to access the updated product documentation on the website.

7.5 Password-protected lock

A password protected lock function allows to inhibit most commands while allowing the free display of all pages. This feature is particularly aimed at non-residential buildings in order to prevent unintended modifications to the preset profiles, e.g. for the chrono-thermostat scheduling or the operating mode. The password is a 4-digit number: for password configuration please refer to *General visualization settings* chapter.

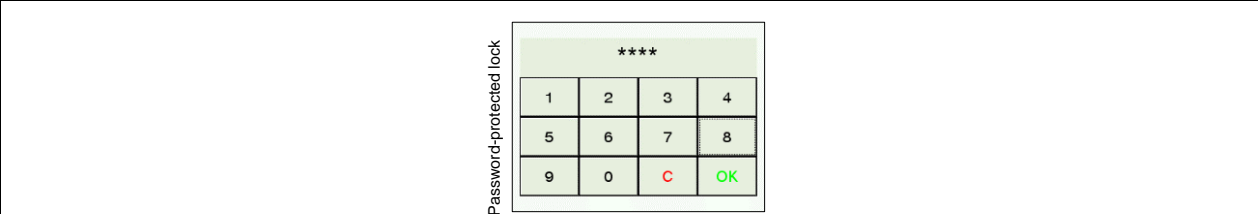

Password protected lock function can only be activated by the system integrator during commissioning.

The password is a 4-digit number (configured during commissioning). In Password page, a short press on (C) cancels the last digit, a short press on (OK) takes to the parameter modification page (if the password is correct, otherwise access is denied and the previous page is displayed).

With password protection unlocked, if nobody touches the screen after 1 min, the parameter modification is automatically locked again.

When the lock is active, the following pages are still completely controllable by the user:

- Multimedia
- Pushbuttons
- Timer (settings page): the user is still allowed to activate and deactivate the pre-programmed events, though he cannot access the page for the activation time settings.

7.6 Graphical themes

Graphical themes can be customized in *Settings* page by selecting GRAPHICAL THEMES. Different color combinations can be selected, changing side column, page background and numeric / text fields appearance.

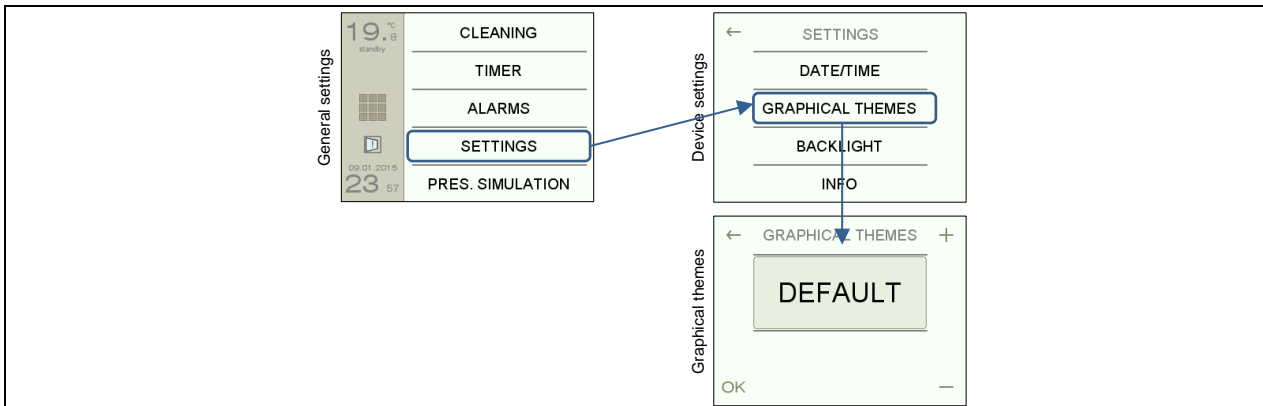

In order to make Touch&See experience more pleasant, graphical themes can be customized with different color combinations for side column, pages background and numeric / text fields appearance.

From Home page, select *General Settings*, then *Settings* and GRAPHICAL THEMES.

The currently selected graphical theme is displayed in the central part of the page: press (+) or (-) to select the desired graphical theme. Confirm with (OK) to activate the new setting, or cancel with (⇐).

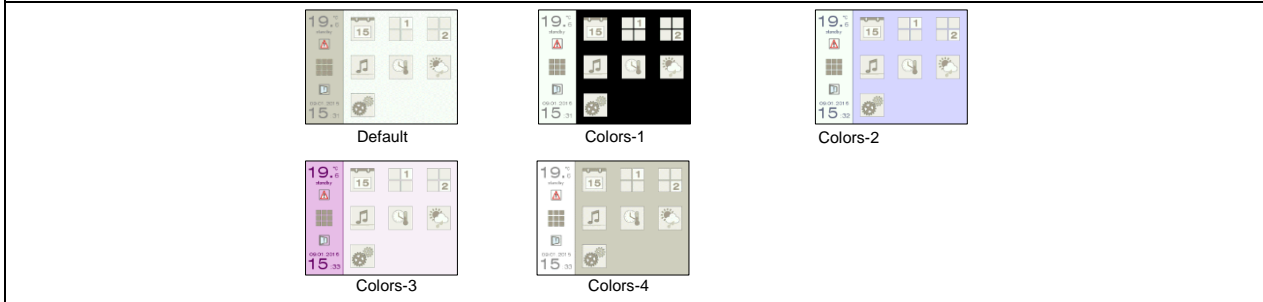

8. General settings

The configuration of the unit, like most KNX devices, heavily depends on what other devices are deployed and active on the KNX bus; it is important for the configuration to be correctly performed starting from the general parameters which involve the device-level functions and the set of required features (and corresponding) pages.

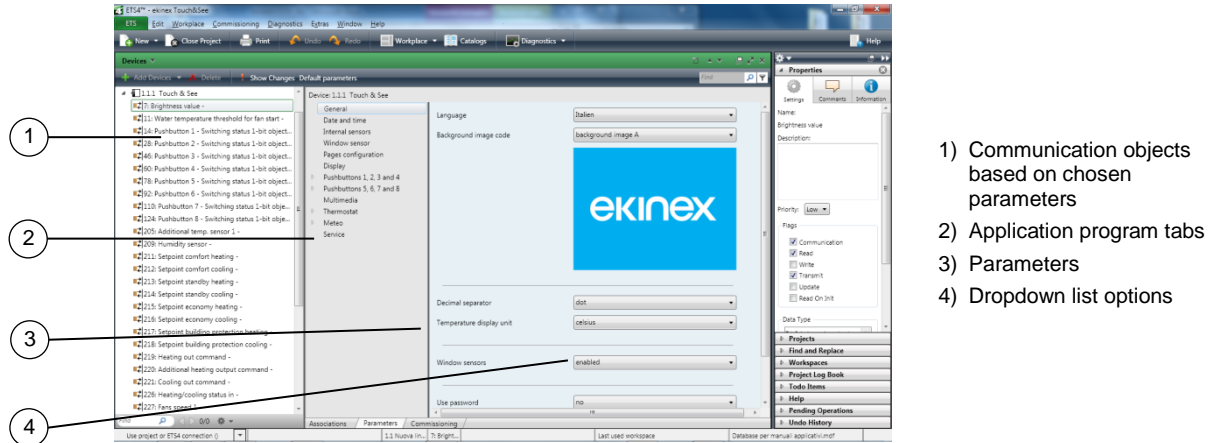

- 1) Communication objects based on chosen parameters
- 2) Application program tabs
- 3) Parameters
- 4) Dropdown list options

From now on, terminology shown in picture above will be used.

8.1 General

Under this tab, following settings are available:

- language for displayed screen texts;
- background image shown at startup and also as a screensaver;
- color of LEDs (graphical pages);
- format used in the display of numeric values;
- LEDs intensity for rockers (EK-EF2-TP only);
- zone names;
- activation of the menu for window contact settings;
- password for page locking function;
- delay after bus voltage recovery.

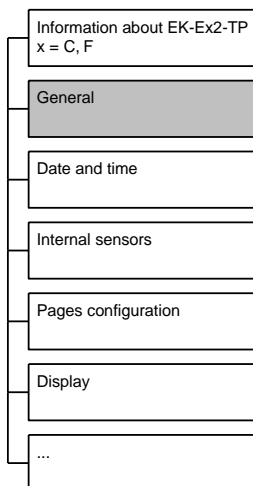

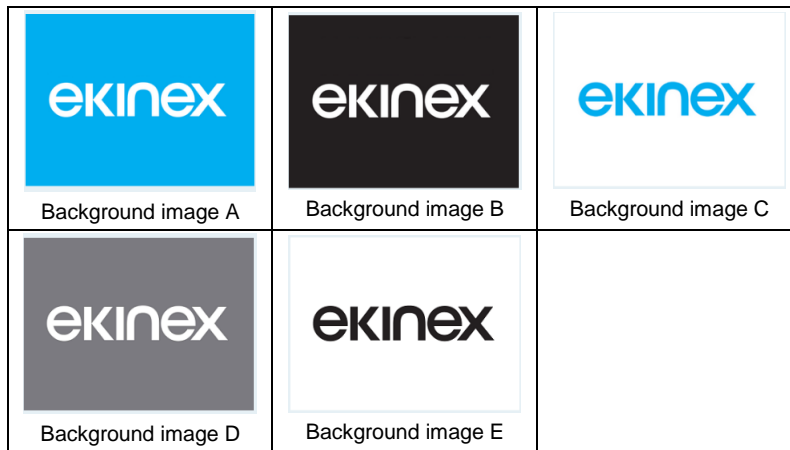

Some text elements that appear in the user interface, such as the name identifiers for window contacts, alarms generated externally to the device, timed events and pushbutton functions, must be configured separately in the appropriate menus in the application program. These texts are a further element of personalization of the device and are independent from the international language selected.

Parameter name	Conditions	Values
Language		english / german / french / italian / other (copied from SD card)
	<i>The parameter sets the language of the text displayed on the screen pages. To load other languages, refer to the section on how to load from the SD card.</i>	
Background image code		Background image A / Background image B / Background image C / Background image D / Background image E / other (copied from SD card)
	<i>To load other background images, refer to the section on how to load from the SD card.</i>	
Color of leds (graphical pages)		Blue-green Red-white
	<i>The parameter allows to select a couple of values for LEDs related to pushbuttons of the command pages. Then all modules configured in the automation system can have graphical LEDs colored in coherent way.¹</i>	
Decimal separator		dot / comma
	<i>Decimal separator used for the display of numeric data</i>	
Temperature display unit		celsius / fahrenheit
	<i>Sets measurement unit for temperature display.</i>	
Leds intensity from bus		no / yes
	<i>Version EK-EF2-TP with 2 rockers only: allows to set the percentage of brightness intensity for leds related to rockers.</i>	
Leds intensity	Leds intensity from bus = no	0% / 10% / 20% / 30% / 40% / 50% / 60% / 70% / 80% / 90% / 100%
	<i>Only for version EK-EF2-TP with 2 rockers.</i>	

¹ In 2.00 program version, the possibility to choose virtual leds colors related to graphical pushbuttons is predisposed but not implemented. First color is always green and second color is blue.

Parameter name	Conditions	Values
Name Zone 1		ASCII text, max. 28 characters
	<p>The maximum length of each text string is 28 characters in standard ASCII code. If the Unicode (UTF-8) character encoding is used, the available string size might be smaller.</p> <p>The strings are static, i.e. they do not change according to the general language setting of the device. The configured text is displayed in the page related to each zone.</p> <p>The name assigned to each zone can also be inserted or modified in one of the following tabs, if enabled: Thermostat Zone X ⇒ Configuration ⇒ Name zone X, Window contact Zone X ⇒ Name zone X.</p>	
Name Zone 2		ASCII text, max. 28 characters
	See above	
Name Zone 3		ASCII text, max. 28 characters
	See above	
Name Zone 4		ASCII text, max. 28 characters
	See above	
Name Zone 5		ASCII text, max. 28 characters
	See above	
Name Zone 6		ASCII text, max. 28 characters
	See above	
Name Zone 7		ASCII text, max. 28 characters
	See above	
Name Zone 8		ASCII text, max. 28 characters
	See above	
Window contacts		<p>disabled</p> <p>1 zone / 2 zones / 3 zones / 4 zones / 5 zones / 6 zones / 7 zones / 8 zones</p>
	Activating this parameter allows to select the building protection operating mode while in open window status, in Thermostat tab.	
Use password		no / yes
	Password is a 4-digit number. If password protection is unlocked, after 1 min since the last interaction with the touchscreen, protection for parameter modification is automatically restored.	
Delay after bus voltage recovery		hh:mm:ss:fff (00:00:04:000)
	The parameter sets the delay between the moment the bus operation is restored and the moment at which the device begins to transmit data. This delay must be carefully planned to prevent that, after a reset following a switch-on of the bus, all devices simultaneously begin to send telegrams, causing an excessive occupation of the available band.	

Object name	Conditions	Dimens.	Flags	DPT	No. Comm. Obj.
Leds intensity percentage	Leds intensity from bus=yes		C-W---	[5.001] percentage (0..100%)	10
	Only for version EK-EF2-TP with 2 rockers.				

8.2 Date and time

This tab allows to configure the following device settings:

- Date and time synchronization through RTC (Real Time Clock) internal circuit provided within the device. Please remind that the device is equipped with an internal backup battery; in case of auxiliary power supply failure, date and time are retained for a fixed time interval. This setting allows the Touch&See unit to synchronize time with other bus devices through proper communication objects;
- Date and time synchronization via bus-received telegram. With this setting, internal RTC clock is not used; all activities requiring time synchronization use date and time received from the bus through proper communication objects;
- Date and time datapoint type. There are 3 types of date and time communication objects updated from the bus or internally updated and sent on the bus: DPT type [19.001] date and time (8 bytes), representing both time and date; DPT [11.001] date (3 bytes), representing date only; DPT [10.001] time of day, representing time only.
- Date and time field format. This setting determines the display format of date and time information in the side band of the screen and, if enabled, in the Calendar page.

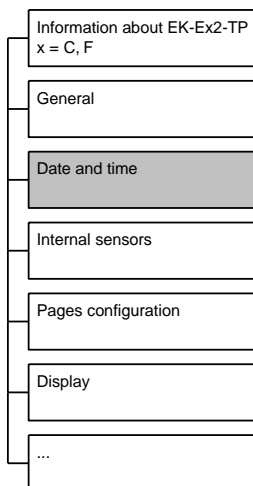

i *With internal date and time configuration, every time a new configuration is downloaded from ETS, correct time and date must be set by the user in the dedicated screen page. Refer to the chapter that describes the user interface for details.*

If date and time are synchronized from the bus, all internal activities regarding Date and Time page, program scheduling and chrono-thermostat, timers and presence simulation, if active, refer to time values coming from the bus.

Internal control system ciclically monitors the state of the periodic update of date and time information from the bus; a timeout for the maximum update delay must be specified. If no update is received within the timeout period, an alarm condition is notified in the Alarms page of the interface.

Parameter name	Conditions	Values
Date separator		. / , / : / - / //
	<i>Separator used for date display.</i>	
First day of week		Monday / Sunday
Date format		dd mm yyyy / mm dd yyyy
	<i>Format used for date display.</i>	

Parameter name	Conditions	Values
Time separator		. / , / : / - / /
<i>Time separator selection in date display.</i>		
Use 12 or 24 hours clock		24 hours / 12 hours
<i>Format used for tim display.</i>		
Use leading zero		no / yes
Date and time synchronization		internal / from bus
Daylight saving time	Date and time synchronization = internal	no / yes
<i>If the internal RTC is used, this setting activates the DST switching at the standard officially defined days of the year.</i>		
Cyclic sending interval	Date and time synchronization = internal	No sending, 30 s, 1 min, 2 min, 3 min, 4 min, 5 min, 7 min, 10 min, 15 min, 20 min, 30 min, 45 min, 60 min, 90 min, 120 min
Date and time object dimension	Date and time synchronization = from bus	8 bytes / 2x3 bytes
Date and time timeout	Date and time synchronization = from bus	1440 min (from 0 to 65535 min)
<i>Internal control system ciclically monitors the state of the periodic update of date and time information from the bus; a timeout for the maximum update delay must be specified. If no update is received within the timeout period, an alarm condition is notified in the Alarms page of the interface. To deactivate the function, set timeout to 0 min.</i>		

Object name	Conditions	Dimens.	Flags	DPT	No. Comm. Obj.
Date and time	Date and time synchronization = from bus Date and time object dimension = 8 bytes	8 Bytes	C-W---	[19.001] date time	1
<i>Object is updated by a telegram from the bus.</i>					
Date	Date and time synchronization = from bus Date and time object dimension = 2x3 bytes	3 Bytes	C-W---	[11.001] date	2
<i>Object is updated by a telegram from the bus.</i>					
Time	Date and time synchronization = from bus Date and time object dimension = 2x3 bytes	3 Bytes	C-W---	[10.001] time of day	3
<i>Object is updated by a telegram from the bus.</i>					
Date and Time	Date and time synchronization = internal Sending on the bus = yes	8 Bytes	CR-T--	[19.001] date time	4
<i>Internal RTC clock updates the communication object sent on the bus.</i>					

Object name	Conditions	Dimens.	Flags	DPT	No. Comm. Obj.
Date	Date and time synchronization = internal Sending on the bus = yes	3 Bytes	CR-T--	[11.001] date	5
<i>Internal RTC clock updates the communication object sent on the bus.</i>					
Time	Date and time synchronization = internal Sending on the bus = yes	3 Bytes	CR-T--	[10.001] time of day	6
<i>Internal RTC clock updates the communication object sent on the bus.</i>					

8.3 Internal sensors

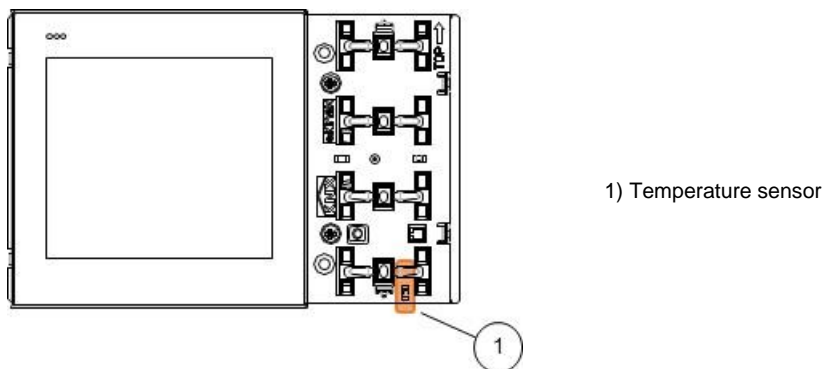

The temperature sensor is geared in version EK-EF2-TP only. It is located under the inferior rocker, facing towards the bottom of the device.

8.3.1 Temperature sensor

Only available in EK-EF2-TP, the integrated temperature sensor allows to measure the ambient temperature with a range of 0-40°C and a resolution of 0.1°C. In order to take account of important ambient interferences like proximity to heat sources, external wall mounting, stack effect caused by warm air ascending through the corrugated pipe connected to the flush mounting box, the measured value can be corrected with a $\pm 5,0$ K offset. The integrated temperature sensor can be configured to display ambient temperature value directly on the side column of the touchscreen (please refer to the user interface chapter for further information). The sensor can also be used to control ambient comfort and can be associated uniquely to ZONE1 among chronothermostat functions. The measured value can be averaged with readings coming from other 4 optional sensors configured on the bus.

8.3.2 Settings

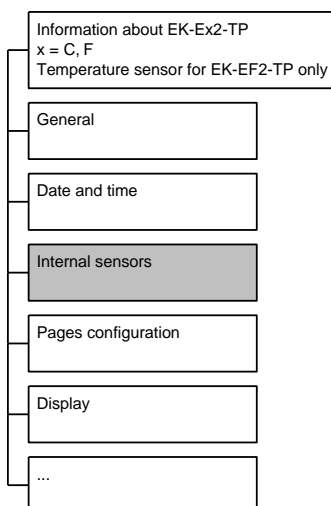

Parameter name	Conditions	Values
Use internal temperature sensor		no / yes
<i>EK-EF2-TP version only</i>		
Temperature offset	Use internal temperature sensor = yes	-5,0°C / -4,5°C / -4,0°C / -3,5°C / -3,0°C / -2,5°C / -2,0°C / -1,5°C / -1,0°C / -0,5°C / 0,0°C / +0,5°C / +1,0°C / +1,5°C / +2,0°C / +2,5°C / +3,0°C / +3,5°C / +4,0°C / +4,5°C / +5,0°C
<i>EK-EF2-TP version only</i>		
Temperature cyclic transmission	Use internal temperature sensor = yes	disabled / enabled
<i>EK-EF2-TP version only</i>		
Minimum change of value to send [K]	Temperature cyclic transmission = enabled	0,5 (range from 0 to 50)
<i>EK-EF2-TP version only. 0 means no value sent on change.</i>		
Transmission interval	Temperature cyclic transmission = enabled	hh:mm:ss (00:05:00)
<i>EK-EF2-TP version only. 00:00:00 means no cyclic transmission.</i>		

8.4 Window contacts

This tab allows the management and configuration of window contacts through communication objects, closed window status attribution and an identifying name. A status icon is displayed on the side column in each page, when at least one contact is signalling the open window status. A short press on the icon takes to the list where the user can identify which contact has provided the information. Please refer to the graphic elements chapter for further information.

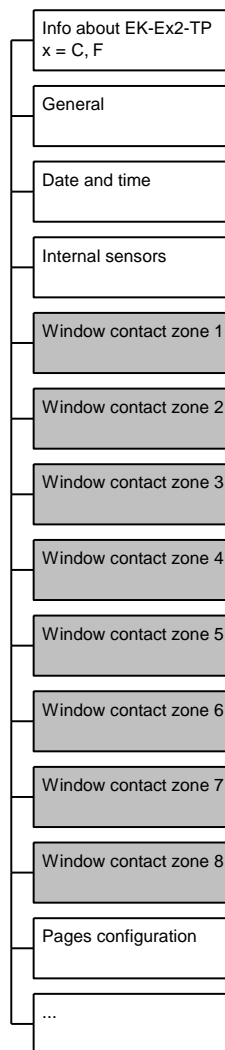

Energy saving management activating building protection operating mode, in case of open window detected, requires activation of related thermostat functions:

Pages configuration ⇒ *Thermostat* = enabled;

Thermostat ⇒ *Heating* ⇒ Use window contacts to activate building protection mode = yes

Thermostat ⇒ *Cooling* ⇒ Use window contacts to activate building protection mode = yes

The *Window Contact Zone X* tab is active if *General tab* ⇒ *Window Contacts* = X zones.

Parameter name	Conditions	Values
Name zone X		ASCII text, max. 28 characters
<p>Please note, while planning the device configuration, that these are static strings, not related with the selected device language. By using Unicode (UTF-8) characters code, the maximum text length can be different from the displayed values. Configured text will be displayed in each zone's page.</p> <p>The name assigned to the zone can be typed or changed in any of the following tabs, if enabled: General ⇒ Name Zone X and Thermostat Zone X ⇒ Configuration ⇒ Name Zone X.</p>		
Number of sensors		1 (range from 1 to 4)
Sensor (Y)		NC (normally closed) NO (normally open)
<p>NC is ON when the window is CLOSED, Off otherwise; NO is ON when the window is OPEN, Off otherwise.</p>		
Name of window sensor (Y)		ASCII text, max. 28 characters
<p>The strings are static, i.e. they do not change according to the general language setting of the device.</p> <p>If the Unicode (UTF-8) character encoding is used, the available string size might be smaller.</p>		

Object name	Conditions	Dimens.	Flags	DPT	No. Comm. Obj.
Zone (X) – Window contact 1		1 Bit	C-W---	[1.019] window / door	(X=1) 702 (X=2) 755 (X=3) 808 (X=4) 861 (X=5) 914 (X=6) 967 (X=7) 1020 (X=8) 1072
Zone (X) – Window contact 2		1 Bit	C-W---	[1.019] window / door	(X=1) 703 (X=2) 756 (X=3) 809 (X=4) 862 (X=5) 915 (X=6) 968 (X=7) 1021 (X=8) 1073
Zone (X) – Window contact 3		1 Bit	C-W---	[1.019] window / door	(X=1) 704 (X=2) 757 (X=3) 810 (X=4) 863 (X=5) 916 (X=6) 969 (X=7) 1022 (X=8) 1074

Object name	Conditions	Dimens.	Flags	DPT	No. Comm. Obj.
Zone (X) – Window contact 4		1 Bit	C-W---	[1.019] window / door	(X=1) 705 (X=2) 758 (X=3) 811 (X=4) 864 ((X=5) 917 (X=6) 970 (X=7) 1023 (X=8) 1075

8.5 Graphical pages

One of the most important planning activities in the whole configuration project is enabling the pages to display on the Touch&See. Communication objects related to the choices made will have to be associated to sensors and actuators distributed on the KNX network.

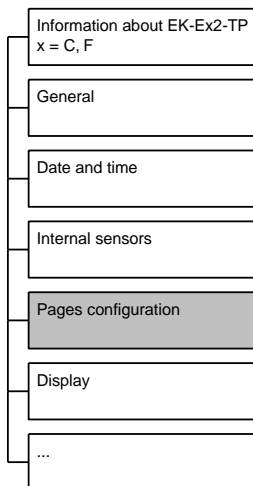

Parameter name	Conditions	Values
Date and time		disabled / enabled
	<i>Enables the Calendar page.</i>	
Push buttons 1, 2, 3 and 4 - A		disabled / enabled
	<i>Enables the first Pushbutton screen page.</i>	
Push buttons 1, 2, 3 and 4 - B		disabled / enabled
	<i>Enables the second Pushbutton screen page.</i>	
Push buttons 1, 2, 3 and 4 - C		disabled / enabled
	<i>Enables the third Pushbutton screen page.</i>	
Push buttons 1, 2, 3 and 4 - D		disabled / enabled
	<i>Enables the fourth Pushbutton screen page.</i>	
Push buttons 1, 2, 3 and 4 - E		disabled / enabled
	<i>Enables the fifth Pushbutton screen page.</i>	
Push buttons 1, 2, 3 and 4 - F		disabled / enabled
	<i>Enables the sixth Pushbutton screen page.</i>	
Push buttons 1, 2, 3 and 4 - G		disabled / enabled
	<i>Enables the seventh Pushbutton screen page.</i>	

Parameter name	Conditions	Values
Push buttons 1, 2, 3 and 4 - H		disabled / enabled
	<i>Enables the eighth Pushbutton screen page.</i>	
Multimedia		disabled / enabled
	<i>Enables the screen page for the control of Multimedia devices.</i>	
Thermostat		disabled / 1 zone / 2 zones / 3 zones / 4 zones / 5 zone / 6 zones / 7 zone / 8 zones
	<i>Enables the Chrono-thermostat screen page(s).</i>	
Meteo		disabled / enabled
	<i>Enables the screen page for meteo information.</i>	
Timers		disabled / enabled
	<i>Enables the access to timer settings in the Service screen page.</i>	
Presence simulation		disabled / enabled
	<i>Enables the access to Presence Simulation parameters in the Service screen page.</i>	
Alarms		disabled / enabled
	<i>Enables the display of external alarms in the Alarm page. Alarms can be associated to communication objects listed in Service ⇒ Alarms tab. The display of the Alarms that are generated internally to the device is always enabled.</i>	

8.6 Display

This tab allows to setup several Touch&See graphic presentation modes to show during inactivity periods. Those modes can be coordinated with the correction of backlight intensity through the parameter *Internal Sensors* ⇒ *Backlight intensity correction*.

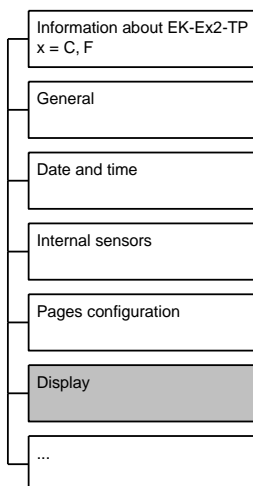

There are 2 available presentation modes:

- Standby: after an adjustable inactivity period, the screen displays a predefined page or the background image. In this latter case, the action corresponds to the activation of a real screensaver. The screensaver image is selected in *General* ⇒ *Background image code*;
- Low power: after an inactivity period, backlight is reduced to an adjustable value.

If low power mode is active, the behavior when the screen is touched has to be defined: to avoid undesired actions and commands, it is possible to restore the backlight only when the screen is touched for the first time.

Proper settings always depend on device destination and user's needs.

Parameter name	Conditions	Values
Standby mode activation delay		hh:mm:ss (00:01:00)
Standby action		none / show page / show background only
Standby page	Standby action = show page	Home / date and time / push buttons A / push buttons B / other push buttons / multimedia / thermostat 1, 2, 3 and 4 / thermostat 5, 6, 7 and 8 / meteo
Low power mode activation delay		hh:mm:ss (00:02:00)
Display brightness		off / 2 % / 5 % / 10 % / 15 % / 20 % / 25 % / 30 %
Behavior when touched		only backlight on / backlight on and goto page
Page	Behavior when touched = backlight on and goto page	Home / date and time / push buttons A / push buttons B / other push buttons / multimedia / thermostat 1, 2, 3 and 4 / thermostat 5, 6, 7 and 8 / meteo

9. Pushbutton command pages

9.1 Graphical elements customization

9.1.1 Pages selection

Based on application type and command / control needs, one or two pages can be configured: *Pushbuttons 1, 2, 3 and 4 – X*, where X = A, B, C, D, E, F, G, H. If a page is not enabled, it will not be displayed. From now on, the pages will be defined as one single page called *Pushbuttons*, since both parameters and functions described are valid for both pages without exceptions.

9.1.2 Horizontal and vertical pushbuttons pairing

The ETS application program comes with 2 different types of pushbutton pairing, each one with a different set of numbers (see picture below). Once the configuration has been downloaded, the coupled pushbuttons will appear as one (in horizontal or vertical direction). For example, by using horizontal pairing and pushbuttons 1-2 coupled, the page will show one pushbutton on the upper side; on the lower side the remaining pushbuttons will still be individually configurable.

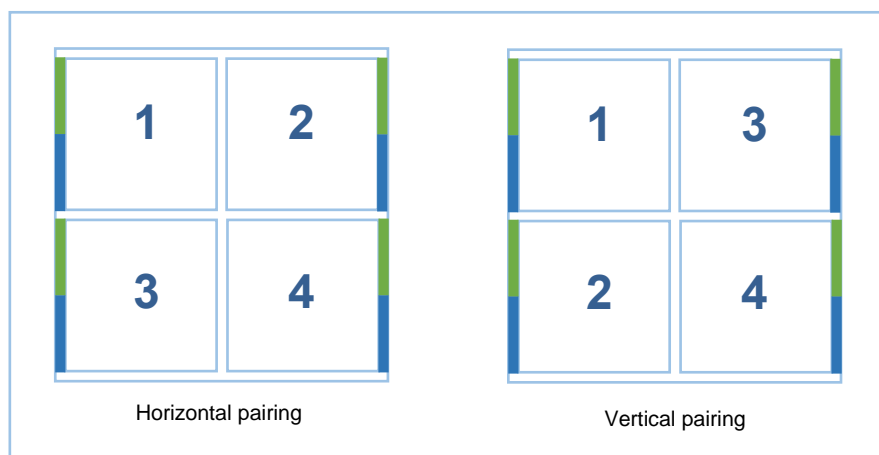

In the pushbutton configuration as single or independent mode, horizontal or vertical pairing has only an identifying meaning. Since the configuration parameters are still numbered, please remember which pairing mode has been selected in order to avoid undesired functionalities.

9.1.3 LED pushbuttons

On the side of each pushbutton, a graphical area that simulates two leds is present, similar to ekinex® KNX pushbuttons EK-EA2-TP and EK-EB2-TP. The led color combination (green / blue or red / white) can be chosen in order to coordinate the graphic interface with all pushbuttons in the building automation system². Leds can be individually configured even if the corresponding pushbuttons are coupled.

The activation of virtual leds can be set in the following ways:

- Constant value (led always on / off);
- Led on when corresponding pushbutton is pressed. With this option, you can specify an additional delay for the led to turn off after the pushbutton is released;
- State determined by the bus through a communication object. In this case, when condition is active, you can decide to make the led blink (with different on / off time selection); furthermore, the on / off

² The virtual LEDs colour selection is available in the General Tab

condition can be reversed, based on the state of the related communication object (led on object value is off and vice-versa).

9.1.4 Pushbutton texts and icons

The graphics for each pushbutton can be customized with a text and two symbols, one identifying the function (for example: lighting, heating, blinds) and one dedicated to the type of action of the pushbutton (for example: increased, decreased, go to next, go to prev). The program offers an extensive library of symbols, similar to those of the ekinex® buttons. See Appendix for displaying the symbol library and matching the codes provided in the ETS application program. You can also use custom symbols loaded via SD card; please refer to the procedures of loading images for further information.

9.2 Online operations

9.2.1 Pushbuttons pairing

The buttons can be configured in the following ways:

- single or independent pushbutton mode: each pushbutton operates independently and has its own parameters and communication objects;
- coupled pushbutton mode: 2 buttons are grouped by a common functionality and, consequently, operate through shared communication objects.

You can configure some buttons as independent and others as coupled with the binding constraints described above.

9.2.2 Single or independent pushbuttons

Each pushbutton can be configured independently to one of the following functions:

1. *Send values or sequences*

A short / long press activates the transmission over the bus of a value or sequences of configurable values. These values can be either logical or numerical with different sizes. A sequence of max. 8 communication objects may be formed, each one with different types and values. If you use only one communication object, you can also configure cyclical sending of states or values.

2. *Dimming*

This mode is used in combination with KNX dimming actuators for lighting devices control. The function is activated only with a short / long press. A short press will make the machine send on / off commands to the dimmer; a long press will change the dimming percentage - rising or falling - until the button is released.

3. *Shutter or venetian blind*

This mode is used in combination with KNX dimming actuators for shutter control, motorized dampers or similar. These actuators have specific functions for shutters opening and closing; you can select two types of movement: continuous or spotted. After pressing the button, the device sends the appropriate telegrams to the actuator. The configuration parameters are the following:

- If *toggle* mode is enabled, each press of a specified pushbutton will reverse the direction; if it is disabled, direction is fixed and can be set as “move down” or “move up”;
- If *venetian blind* mode is enabled, the device sends a “step” command in case of a short press or “open / close all” in case of a long press; if it is disabled, the device sends a “open / close all” command in case of a short press or “stop” in case of a long press.

4. *Scene*

This mode is used in combination with KNX units supporting the scene function. This functionality allows to save and recall a scene communication object; in particular, the device sends a “save” or “recall” scene to the actuators when a short / long press is performed. Configuration options are the following:

- A short press activates the scene, a long press will save the current configuration as the selected scene;
- A short press activates a scene, while a long press activates a different one.

9.2.3 Coupled pushbuttons

Each binded couple of pushbuttons can be configured for one of the following functionalities (only the differences with the independent mode are highlighted).

1. *Switching*

The two couple inputs are associated to the same communication object. Unlike single mode, object can be only 1-bit (on / off) type, thus making a conventional switching. The system integrator can choose which one of the two buttons connect with “on” or “off” function.

2. *Dimming*

Dimming function uses short / long presses on buttons. The system integrator can choose which one of the two buttons connects with “increase” or “decrease” function. A short press on the pushbutton configured as “increase” will make the device send an “on” command, while the “decrease” pushbutton will send an “off” command. A long press will increase or decrease the dimming percentage until the pushbutton is released.

3. *Shutter or venetian blind*

The 2 coupled buttons are assigned to opposite and configurable directions of movement, namely (X) open / go upwards and (X+1) close / go downwards. It is possible to select “venetian blind” mode, whose behavior is the same as independent buttons.

When coupled mode is selected, “Scene” mode is not available.

9.2.4 Cyclic sending

With many features, it is possible to set a telegram sending not only when a state value changes (typically this happens after a short / long press event), but also according to regular time intervals when that particular state is active. This behavior, also known as *Cyclic sending*, can be separately set for each of the two states associated with a button. If an independent pushbutton is set in “send values or sequences” mode, cyclic sending is available only if a single communication object is associated with the pushbutton itself.

9.2.5 Lock function

For each independent pushbutton you can separately enable a lock function allowing to inhibit the function performed through a bus telegram. Deactivation itself is performed through a telegram. When a pushbutton is in locked state, it is in fact disabled. It is possible to specify a value to assign to a proper communication object corresponding to each transition, both in and out of the lock. Lock status can be automatically activated at power-up, after a power supply failure.

9.3 Device settings

9.3.1 Pushbuttons configuration

In the ETS application program two main tabs for pushbutton programming are available, respectively called “Push buttons 1, 2, 3 and 4 - X”, where X = A, B, C, D, E, F, G, H. The activation of these tabs depends on the following parameter configuration:

Pages Configuration ⇒ Push buttons 1, 2, 3 and 4 – X ⇒ enabled

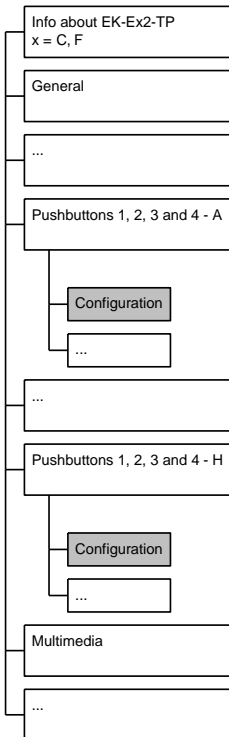

From now on, we will refer to a generic pushbutton configuration tab, since all described parameters and communication objects described may apply to both sets of tabs.



In order to correctly define the result of the settings made with the following parameters, the placement selected with the “pushbutton pairing” parameter (horizontal or vertical) must be taken into account.

Parameter name	Conditions	Values
Pushbuttons pairing		horizontal / vertical
Pushbuttons 1 and 2		disabled / independent / coupled
	<i>If the “coupled” option is selected, the paired pushbuttons will be displayed as a single pushbutton surface without separation line.</i>	
Pushbutton 1	Pushbuttons 1 and 2 = independent	disabled / enabled

Parameter name	Conditions	Values
Type	Pushbuttons 1 and 2 = independent, Pushbutton 1 = enabled	send values or sequences dimming shutter or venetian blind scene
Pushbutton 2		disabled / enabled / copy parameters from pushbutton 1
<i>If the option "copy parameters from pushbutton" is selected, all settings of the source pushbutton will be used for the destination pushbutton; for this latter one, though, a set of own communication objects will be activated.</i>		
Type	Pushbuttons 1 and 2 = independent, Pushbutton 2 = enabled	send values or sequences dimming shutter or venetian blind scene
Type	Pushbuttons 1 and 2 = coupled	switching / dimming / shutter or venetian blind
Pushbuttons 3 and 4		disabled / independent / coupled / copy parameters from pushbutton 1 and 2
<i>If the "coupled" option is selected, the paired pushbuttons will be displayed as a single pushbutton surface without separation line. If the option "copy parameters from pushbutton" is selected, all settings of the source pushbutton will be used for the destination pushbutton; for this latter one, though, a set of own communication objects will be activated.</i>		
Pushbutton 3	Pushbuttons 3 and 4 = independent	disabled / enabled
Type	Pushbuttons 3 and 4 = independent, Pushbutton 3 = enabled	send values or sequences dimming shutter or venetian blind scene
Pushbutton 4		disabled / enabled / copy parameters from pushbutton 3
<i>If the option "copy parameters from pushbutton" is selected, all settings of the source pushbutton will be used for the destination pushbutton; for this latter one, though, a set of own communication objects will be activated.</i>		
Type	Pushbuttons 3 and 4 = independent, Pushbutton 4 = enabled	send values or sequences dimming shutter or venetian blind scene
Type	Pushbuttons 3 and 4 = coupled	switching / dimming / shutter or venetian blind

9.3.2 Pushbutton X (independent mode)

9.3.2.1 Pushbutton X: send values or sequences

This tab allows to send single telegrams or sequences of telegrams in correspondence of a short or long press of each independent pushbutton. This feature is very useful in a lot of applications, because you can define sequences for up to 8 communication objects of different types and different short / long press values. If a single communication object is sent, it is also possible to configure the cyclic sending of one or both values.

Pushbutton X tab is activated under the following conditions:

Configuration ⇒ *Pushbuttons X and next = Independent*

Configuration ⇒ *Pushbutton X = Enabled*

Configuration ⇒ *Pushbutton X* ⇒ *Type = Send values or sequences*

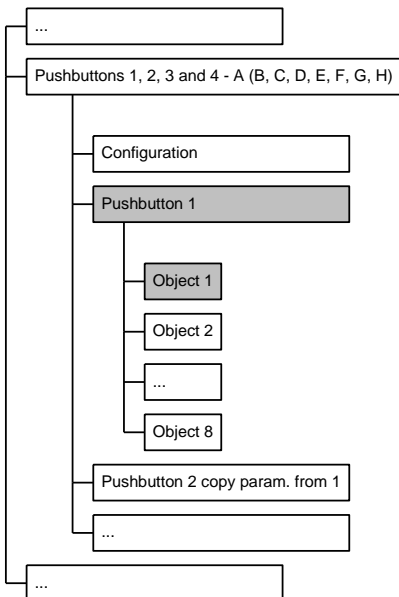

Based on the selected communication object number, Object X tabs are activated. Object X tabs allow to define the data type for each communication object and the reactions to the pushbutton press events.

Parameter name	Conditions	Values
Lock function		disabled / enabled
	<i>Enables or disables the capability of locking the pushbutton through a remote command (telegram). If this feature is enabled, a remote command can inhibit the pushbutton action or trigger the sending of values associated to a short / long press, in case of lock command activated or deactivated.</i>	
Number of communication objects		1 (range from 1 to 8)
	<i>Number of communication objects configured in association with the button event (short or long press).</i>	
Long press time		hh:mm:ss:fff (00:00:03:000)
	<i>Minimum push time for a press in order to be determined as a long press.</i>	

9.3.2.2 Object X: send values or sequences

Parameter name	Conditions	Values
Send delay		hh:mm:ss:ff (00:00:00:00)
<i>Defines the command execution delay after a short or long press.</i>		
Send cyclically	Pushbutton X ⇒ Number of communication objects = 1	none off / value 1 on / value 2 both off and on / both values
<i>Cyclic sending option is active only if a single communication object is defined for pushbutton X.</i>		
Cyclic sending interval	Pushbutton X ⇒ Number of communication objects = 1 Cyclic sending ≠ none	hh:mm:ss (00:02:00)
<i>Cyclic sending option is active only if a single communication object is defined for pushbutton X.</i>		
Communication object dimension		1 bit value, 2 bit value, 1 byte unsigned value, 1 byte percentage, 1 byte signed value, 2 byte unsigned value, 2 byte signed value, 2 byte floating value
Reaction to short press	Communication object dimension = 1 bit value	none off on toggle
Reaction to long press	Communication object dimension = 1 bit value	none off on toggle
Reaction to short press	Communication object dimension = 2 bit value	none disable enable off / up enable on / down enable off / up ⇔ disable enable on down ⇔ disable enable off / up ⇔ enable on down
Reaction to long press	Communication object dimension = 2 bit value	none disable enable off / up enable on / down enable off / up ⇔ disable enable on down ⇔ disable enable off / up ⇔ enable on down

Parameter name	Conditions	Values
Reaction to short press	Communication object dimension = 1 byte unsigned value, 1 byte percentage, 1 byte signed value, 2 byte unsigned value, 2 byte signed value, 2 byte floating value	none send value 1 send value 2 send value 1 ↔ send value 2
Reaction to long press	Communication object dimension = 1 byte unsigned value, 1 byte percentage, 1 byte signed value, 2 byte unsigned value, 2 byte signed value, 2 byte floating value	none send value 1 send value re 2 send value 1 ↔ send value 2
Value 1	Communication object dimension = 1 byte unsigned value, 1 byte percentage, 1 byte signed value, 2 byte unsigned value, 2 byte signed value, 2 byte floating value	0 (0..255) 0 (0..100) 0 (-128..127) 0 (0..65535) 0 (-32768..32767) 0 (-671088,64..670760,96)
Value 2	Communication object dimension = 1 byte unsigned value, 1 byte percentage, 1 byte signed value, 2 byte unsigned value, 2 byte signed value, 2 byte floating value	0 (0..255) 0 (0..100) 0 (-128..127) 0 (0..65535) 0 (-32768..32767) 0 (-671088,64..670760,96)

Object name	Conditions	Dimens.	Flags	DPT	No. Comm. Obj.
Pushbutton X – Switching status 1-bit object 1	Communication object dimension = 1 bit value	1 Bit	CRWTU-	[1.001] switch	14, 28, 46, 60, 78, 92, 110, 124, 142, 156, 174, 188, 206, 220, 238, 252, 270, 284, 302, 316, 334, 348, 366, 380, 398, 412, 430, 444, 462, 476, 494, 508
<p><i>All addresses listed for the communication objects refer to Object 1 of each independent pushbutton. To identify Object n you need to sum (n-1) to the indicated address. Eg: Pushbutton 5, Object 4 has address 78 + (4-1) = 81</i></p>					

Object name	Conditions	Dimens.	Flags	DPT	No. Comm. Obj.		
Pushbutton X – Switching status 2-bit object 1	Pushbutton X – Switching status 2-bit object 1	2 Bit	CRWTU-	[2.001] switch control, [2.008] direction control 1	14, 28, 46, 60, 78, 92, 110, 124, 142, 156, 174, 188, 206, 220, 238, 252, 270, 284, 302, 316, 334, 348, 366, 380, 398, 412, 430, 444, 462, 476, 494, 508		
<p>2 bit</p> <p>Bit number</p> <table border="1" style="margin: auto;"> <tr> <td style="padding: 5px;">1</td> <td style="padding: 5px;">0</td> </tr> </table> <p style="margin-left: 100px;">0 = off, 1 = on</p> <p style="margin-left: 100px;">0 = No priority, 1 = Priority</p> <p><i>This communication object allows to force an output. The object consists of 2 bits: the less significant determines the command priority, the most significant determines the command status. Generally speaking, in case of a command without priority (no priority), the command value does not affect the actuator status to whom the command is issued.</i></p>						1	0
1	0						
Pushbutton X – Switching status 1-unsigned byte object 1	Communication object dimension = 1 byte unsigned value, 1 byte percentage	1 Byte	CRWTU-	[5.001] percentage (0..100%) [5.010] counter pulses (0..255)	14, 28, 46, 60, 78, 92, 110, 124, 142, 156, 174, 188, 206, 220, 238, 252, 270, 284, 302, 316, 334, 348, 366, 380, 398, 412, 430, 444, 462, 476, 494, 508		
Pushbutton X – Switching status 1-signed byte object 1	Communication object dimension = 1 byte signed value	1 Byte	CRWTU-	[6.001] percentage (-128..127%), [6.010] counter pulses (-128..127%)	14, 28, 46, 60, 78, 92, 110, 124, 142, 156, 174, 188, 206, 220, 238, 252, 270, 284, 302, 316, 334, 348, 366, 380, 398, 412, 430, 444, 462, 476, 494, 508		
Pushbutton X – Switching status 2-unsigned bytes object 1	Communication object dimension = 2 byte unsigned value	2 Bytes	CRWTU-	[7.001] pulses	14, 28, 46, 60, 78, 92, 110, 124, 142, 156, 174, 188, 206, 220, 238, 252, 270, 284, 302, 316, 334, 348, 366, 380, 398, 412, 430, 444, 462, 476, 494, 508		

Object name	Conditions	Dimens.	Flags	DPT	No. Comm. Obj.
Pushbutton X – Switching status 2-signed bytes object 1	Communication object dimension = 2 byte signed value	2 Bytes	CRWTU-	[8.001] pulses difference	14, 28, 46, 60, 78, 92, 110, 124, 142, 156, 174, 188, 206, 220, 238, 252, 270, 284, 302, 316, 334, 348, 366, 380, 398, 412, 430, 444, 462, 476, 494, 508
Pushbutton X – Switching status 2-bytes floating value object 1	Communication object dimension = 2 byte floating value	2 Bytes	CRWTU-	[9.xxx]	14, 28, 46, 60, 78, 92, 110, 124, 142, 156, 174, 188, 206, 220, 238, 252, 270, 284, 302, 316, 334, 348, 366, 380, 398, 412, 430, 444, 462, 476, 494, 508

9.3.2.3 Pushbutton X: dimming

This tab allows to link the commands for a dimming actuator (lighting device or blinds) to a pushbutton. A short press in simple mode can be associated to shutdown (closing) or power-up (opening); in toggle mode a short press automatically switches between off and on status. A long press, instead, can be associated to both increasing and decreasing of brightness.

Pushbutton X tab displays the parameters for dimming configuration with the following conditions:

Configuration ⇒ *Pushbuttons X and next* = Independent

Configuration ⇒ *Pushbutton X* = Enabled

Configuration ⇒ *Pushbutton X* ⇒ *Type* = Dimming

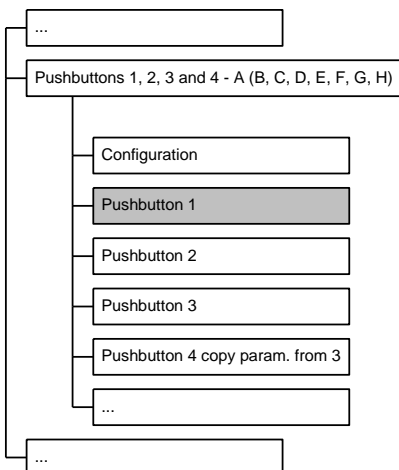

Parameter name	Conditions	Values
Lock function		disabled / enabled
Enables or disables the capability of locking the pushbutton through a remote		

Parameter name	Conditions	Values
		command (telegram). If this feature is enabled, a remote command can inhibit the pushbutton action or trigger on or off state (or a toggle between the two states), in case of lock command activated or deactivated.
Long press time		hh:mm:ss:ff (00:00:03:00)
		Minimum push time for a press in order to be recognized as a long press.
Toggle mode		disabled / enabled
		<i>When enabled, causes the short press to toggle the on-off status of the destination CO; otherwise, a fixed status can be assigned to the short press.</i>
Short / long action	Toggle mode = disabled	off / darker on / brighter off / (darker ↔ brighter) on / (darker ↔ brighter)
		Defines the function to be assigned to the long and short press.
Reaction to long press	Toggle mode = enabled	darker brighter darker ↔ brighter
		<i>Defines the function to be assigned to the long press. If the toggle mode is enabled, the Short press action is already defined as toggle.</i>
Send cyclically		none off / value 1 on / value 2 both off and on / both values
		<i>Defines which of the values, if any, must be cyclically retransmitted whenever activated.</i>
Cyclic sending interval	Cyclic sending ≠ none	30 s / 1 min / 2 min / 3 min / 4 min / 5 min / 7 min / 10 min / 15 min / 20 min / 30 min / 45 min / 60 min / 90 min / 120 min
		Interval between cyclical transmissions.

Object name	Conditions	Dimens.	Flags	DPT	No. Comm. Obj.
Pushbutton X – Switching command		1 Bit	CRWTU-	[1.001] switch	22, 36, 54, 68, 86, 100, 118, 132, 150, 164, 182, 196, 214, 228, 246, 260, 278, 292, 310, 324, 342, 356, 374, 388, 406, 420, 438, 452, 470, 484, 502, 516
					<i>Sends a command to a dimming actuator to switch the light on or off. The command is triggered by a short press on the input. The value sent can be a fixed value or it can be toggled at each input activation.</i>

Object name	Conditions	Dimens.	Flags	DPT	No. Comm. Obj.
Pushbutton X – Dimming up / down / stop command		4 Bit	CR-T--	[3.007] dimming control, [3.008] blind control	23, 37, 55, 69, 87, 101, 119, 133, 151, 165, 183, 197, 215, 229, 247, 261, 279, 293, 311, 325, 343, 357, 375, 389, 407, 421, 439, 453, 471, 485, 503, 517

Sends a command to a dimming actuator to change dimming intensity (brighter or darker). Three values are used which mean start increase, start decrease or stop the change.

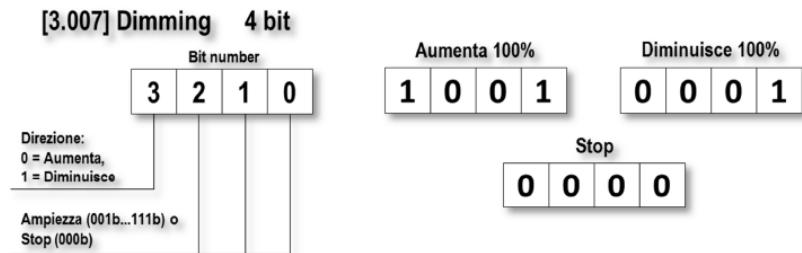

Increase / decrease values are sent when a long press action occurs and stop value on press release.

The value sent can be a fixed value or it can be toggled at each input activation.

If the dimming command is used to control an actuator for shutters or blinds, the type of the used communication object is DPT 3.008 (blind control) whose values are "open" and "close".

9.3.2.4 Pushbutton X: shutter or venetian blind

This tab allows to link a pushbutton to the commands for actuating a shutter or a venetian blind.

The following table shows the different operating modes depending on the parameters selected values.

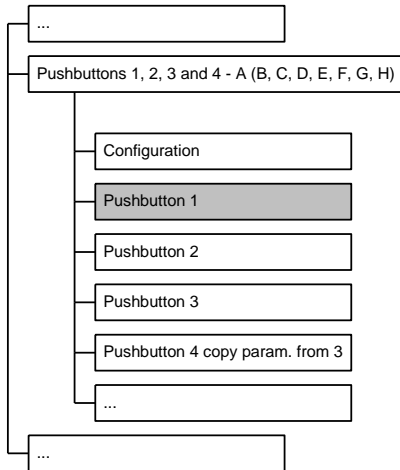

	Short press		Long press	
	Toggle disabled	Toggle enabled	Toggle disabled	Toggle enabled
Venetian blind mode disabled	Up until it stops Down until it stops	Alternatively up or down until it stops	Stop if venetian blind is moving	
Venetian blind mode enabled	Opening step or stop Closing step or stop	Alternatively opening or closing step or stop	Up until it stops Down until it stops	Alternatively up or down until it stops

Pushbutton X tab displays the settings for shutters or blinds with the following conditions:

Configuration ⇒ *Pushbuttons X and next = Independent*

Configuration ⇒ *Pushbutton X = Enabled*

Configuration ⇒ *Pushbutton X* ⇒ *Type = Shutter or venetian blind*

Parameter name	Conditions	Values
Lock function		disabled / enabled
	Enables or disables the capability of locking the pushbutton through a remote command (telegram). If this feature is enabled, a remote command can inhibit the pushbutton action or trigger shutter or venetian blind up or down movement in case of lock command activated or deactivated.	
Long press time		hh:mm:ss:ff (00:00:03:00)
	Minimum push time for a press in order to be recognized as a long press.	
Toggle mode		disabled / enabled
	<i>When enabled, consecutive short presses reverse the direction of movement is reversed; otherwise, a constant value (up or down) is associated to a short press.</i>	
Up / down action	Toggle mode = disabled	down / up
	Defines the movement direction to be assigned to the button press.	

Parameter name	Conditions	Values
Venetian blind mode		disabled / enabled
<i>If blinds mode is enabled, the device sends "full movement" telegrams on long press and "step" telegrams on short press; if it is disabled, the device sends "full movement" telegrams on long press and "stop" telegrams on short press.</i>		

Object name	Conditions	Dimens.	Flags	DPT	No. Comm. Obj.
Pushbutton X – dedicated stop command	Venetian blind mode = disabled	1 Bit	CRWTU-	[1.017] trigger	22, 36, 54, 68, 86, 100, 118, 132, 150, 164, 182, 196, 214, 228, 246, 260, 278, 292, 310, 324, 342, 356, 374, 388, 406, 420, 438, 452, 470, 484, 502, 516
<i>Immediately stops any movement of the blind. The object is sent on release after a long press (if the venetian blind mode is disabled).</i>					
Pushbutton X – Stop-step up / down command	Venetian blind mode = enabled	1 Bit	CR-T--	[1.007] step	24, 38, 56, 70, 88, 102, 120, 134, 152, 166, 184, 198, 216, 230, 248, 262, 280, 294, 312, 326, 344, 358, 376, 390, 408, 422, 440, 454, 472, 486, 504, 518
<i>Increases or decreases the opening of the blind stepwise, or interrupt an ongoing movement.</i>					
Pushbutton X – up / down		1 Bit	CRWTU-	[1.008] up / down	25, 39, 57, 71, 89, 103, 121, 135, 153, 167, 185, 199, 217, 231, 249, 263, 281, 295, 313, 327, 345, 359, 377, 391, 409, 423, 441, 455, 473, 487, 505, 519
<i>Moves the blind to fully open or fully closed position. The object is sent either on first press (if the venetian blind mode is disabled) or on long press (if the venetian blind mode is enabled).</i>					

9.3.2.5 Pushbutton X: scene

This tab allows to link a short press of the pushbutton to a scene recall or a toggle mode recall of two alternative scenes. It is also possible to set the learning mode: in this case, after a short press a scene is recalled, while after a long press the device sends a telegram allowing to save the state associated to the corresponding scene.

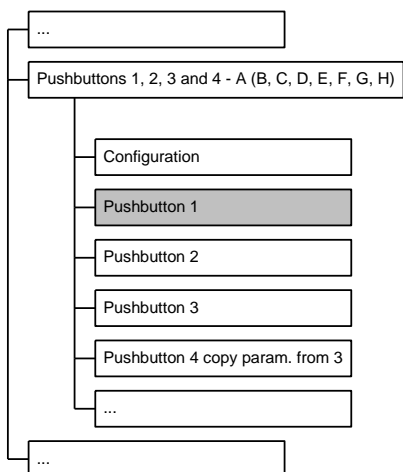

Pushbutton X scene tab displays the scene configuration parameters if:

Configuration ⇒ Pushbuttons X and next = Independent

Configuration ⇒ Pushbutton X = Enabled

Configuration ⇒ Pushbutton X ⇒ Type = Scene

Parameter name	Conditions	Values
Lock function		disabled / enabled
	Enables or disables the capability of locking the pushbutton through a remote command (telegram). If this feature is enabled, a remote command can inhibit the pushbutton action or trigger two alternative scenes in case of lock command activated or deactivated.	
First scene number		1..63 (1)
	<i>Main scene number to link to the pushbutton. It is labeled as "first" because you can define an alternative second scene number to link to a short press in toggle mode.</i>	
Learning mode		disabled / enabled
	<i>If enabled, a long press can trigger the memorization of the current configuration with the assigned scene number.</i>	
Long press time	Learning mode = enabled	hh:mm:ss:ff (00:00:03:000)
	Minimum push time for a press in order to be recognized as a long press.	
Scene activation	Learning mode = disabled	Send first scene only, Toggle between 2 scenes
	Allows the key to be used to alternate between two different scenes.	
Second scene number	Scene activation = Toggle between 2 scenes	1..63 (2)
	Alternate scene number to be assigned to button press.	

Object name	Conditions	Dimens.	Flags	DPT	No. Comm. Obj.
Pushbutton X – scene number		1 Byte	CRWTU-	[17.001] scene number, [18.001] scene control	26, 40, 58, 72, 90, 104, 122, 136, 154, 168, 186, 200, 218, 232, 250, 264, 282, 296, 314, 328, 346, 360, 378, 392, 410, 424, 442, 456, 474, 488, 506, 520

Saves or recalls a scene.

The lowest 6 bits in the byte form the code of the scene, while the highest bit is the operation code (save or recall).

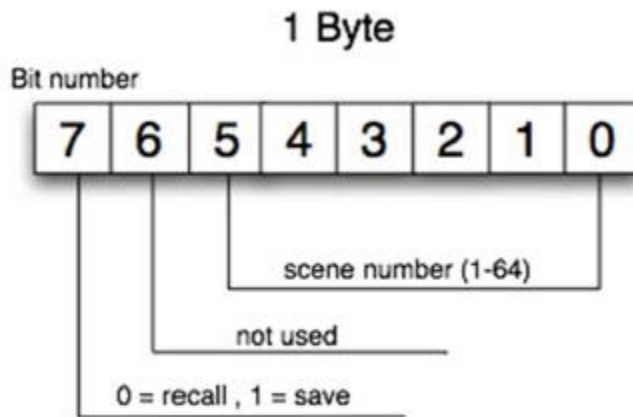

9.3.2.6 Pushbutton X: lock function

The lock function tab contains the parameters associated to the independent pushbuttons in case of locking, unlocking and bus line recovery after a power supply failure. Lock is always determined by a communication object state updated by the bus. Both lock and unlock actions depend on the type of function associated to the independent pushbuttons, such as values or sequences sending, dimming, blinds or venetian blinds command and scenes management.

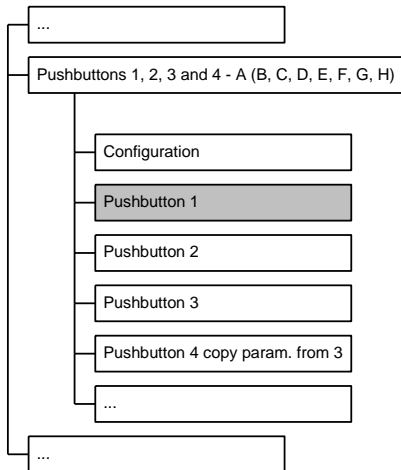

The *Lock function* tab is active if:

Configuration ⇒ *Pushbuttons X and next = Independent*

Configuration ⇒ *Pushbutton X = Enabled*

Parameter name	Conditions	Values
Invert lock device signal	Configuration -> Pushbutton X = enabled Pushbutton X -> Lock function = enabled	not inverted / inverted
	<i>Allows to interpret a "lock activate" telegram as unlock and vice-versa, for example: device lock active when an "off" command through communication object is received. This feature allows to bind the lock command to values of signals having an opposite polarity.</i>	
Lock after bus recovery	Configuration -> Pushbutton X = enabled Pushbutton X -> Pushbutton = enabled	no / yes
	<i>If active, after returning from a bus failure or power-off the device will retain the lock status it had before. Otherwise (in the default case), the device will restart in the non-locked condition.</i>	
Behavior at locking	Configuration -> Pushbutton X = enabled Pushbutton X -> Pushbutton = enabled Configuration -> Type = send values or sequences	none / as close or short press / as open or long press
	<i>Specifies the behavior at locking when pushbutton X is configured as "send values or sequences".</i>	

Parameter name	Conditions	Values
Behavior at unlocking	Configuration -> Pushbutton X = enabled Pushbutton X -> Pushbutton = enabled Configuration ->Type = send values or sequences	none / as close or short press / as open or long press
<i>Specifies the behavior at unlocking when pushbutton X is configured as "send values or sequences".</i>		
Behavior at locking	Configuration -> Pushbutton X = enabled Pushbutton X -> Pushbutton = enabled Configuration ->Type = dimming	none off on toggle
<i>Specifies the behavior at locking when pushbutton X is configured as "dimming" type.</i>		
Behavior at unlocking	Configuration -> Pushbutton X = enabled Pushbutton X -> Pushbutton = enabled Configuration ->Type = dimming	none off on as previous
<i>Specifies the behavior at unlocking when pushbutton X is configured as "dimming" type.</i>		
Behavior at locking	Configuration -> Pushbutton X = enabled Pushbutton X -> Pushbutton = enabled Configuration ->Type = shutter or venetian blind	none up down
<i>Specifies the behavior at locking when pushbutton X is configured as "shutter or venetian blind" type.</i>		
Behavior at unlocking	Configuration -> Pushbutton X = enabled Pushbutton X -> Pushbutton = enabled Configuration ->Type = shutter or venetian blind	none up down
<i>Specifies the behavior at unlocking when pushbutton X is configured as "shutter or venetian blind" type.</i>		
Behavior at locking	Configuration -> Pushbutton X = enabled Pushbutton X -> Pushbutton = enabled Configuration ->Type = scene	none send first scene send second scene
<i>Specifies the behavior at locking when pushbutton X is configured as "scene" type. The numbers associated to the first and second scene are those selected in the Pushbutton X tab. To activate this behavior at locking, you need to disable the scene learning mode for pushbutton X.</i>		
Behavior at unlocking	Configuration -> Pushbutton X = enabled Pushbutton X -> Pushbutton = enabled Configuration ->Type = scene	none send first scene send second scene
<i>Specifies the behavior at unlocking when pushbutton X is configured as "scene" type. The numbers associated to the first and second scene are those selected in the Pushbutton X tab. To activate this behavior at locking, you need to disable the scene learning mode for pushbutton X.</i>		

The following table shows the different option of behavior to locking and unlocking:

Function type	Behavior at locking	Behavior at unlocking
Send values or sequences	none as close or short press as open or long press	
Dimming	none off on toggle	none off on as previous
Shutter or venetian blind	none up down	
Scene	none send first scene send second scene	

Object name	Conditions	Dimens.	Flags	DPT	No. Comm. Obj.
Pushbutton X – Lock command		1 Bit	C-W---	[1.003] enable	13, 27, 45, 59, 77, 91, 109, 123, 141, 155, 173, 187, 205, 219, 237, 251, 269, 283, 301, 315, 333, 347, 365, 379, 397, 411, 429, 443, 461, 475, 493, 507

9.3.3 Pushbutton X and next (coupled mode)

9.3.3.1 Switching

This tab allows to link two coupled pushbuttons to 2 states of a binary 1-bit command. This feature does not make a difference between short and long press.



In order to correctly define the result of the settings made with the following parameters, the placement selected with the "pushbutton pairing" parameter (horizontal or vertical) must be taken into account.

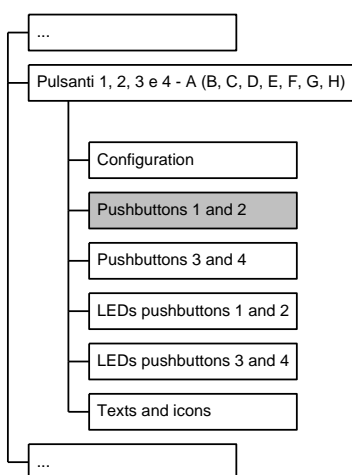

Pushbutton X tab displays the switching configuration parameters with the following conditions:

Configuration ⇒ Pushbuttons X and next = Coupled

Configuration ⇒ Pushbutton X = Enabled

Configuration ⇒ Pushbutton X ⇒ Type = Switching

Parameter name	Conditions	Values
Lock function		disabled / enabled
	Enables or disables the capability of locking the pushbuttons through a remote command (telegram from bus). If this feature is enabled, a remote command can inhibit the pushbuttons action or trigger the on / off state (or a toggle between the two states) in case of lock command activated or deactivated.	
Pushbuttons use		(X) on, (X+1) off (X) off, (X+1) on
	Defines the state of the binary command to pair to each pushbutton.	
Send cyclically		none off / value 1 on / value 2 both off and on / both values
	Defines which of the values, if any, must be cyclically retransmitted whenever activated.	
Cyclic sending interval	Cyclic sending ≠ none	30 s / 1 min / 2 min / 3 min / 4 min / 5 min / 7 min / 10 min / 15 min / 20 min / 30 min / 45 min / 60 min / 90 min / 120 min
	Interval between cyclical transmissions.	

Object name	Conditions	Dimens.	Flags	DPT	No. Comm. Obj.
Pushbuttons (X) and (X+1) – switching command		1 Bit	CRWTU-	[1.001] switch	22, 54, 86, 118, 150, 182, 214, 246, 278, 310, 342, 374, 406, 438, 470, 502

9.3.3.2 Dimming

This tab allows to link the commands for a dimming actuator (lighting device or blinds) to 2 coupled pushbuttons. Each pushbutton can be associated to shutdown (short press) and decreasing of brightness (long press), or power-up (short press) and increasing of brightness (long press).



In order to correctly define the result of the settings made with the following parameters, the placement selected with the "pushbutton pairing" parameter (horizontal or vertical) must be taken into account.

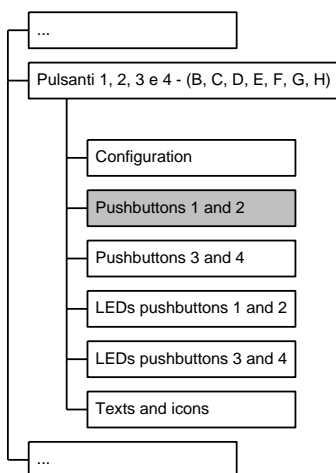

Pushbutton X tab displays the dimming configuration parameters with the following conditions:

Configuration ⇒ Pushbuttons X and next = Coupled

Configuration ⇒ Pushbutton X ⇒ Type = Dimming

Parameter name	Conditions	Values
Lock function		disabled / enabled
	Enables or disables the capability of locking the pushbuttons through a remote command (telegram from bus). If this feature is enabled, a remote command can inhibit the pushbuttons action or trigger the on / off state (or a toggle between the two states) in case of lock command activated or deactivated.	
Long press time		hh:mm:ss:ff (00:00:03:000)
	Minimum push time for a press in order to be recognized as a long press.	
Pushbuttons use		(X) increases, (X+1) decreases (X) decreases, (X+1) increases
	Defines the action to be assigned to a long press. The short press action is automatically assigned to On / Off switching.	

Parameter name	Conditions	Values
Send cyclically		none off / value 1 on / value 2 both off and on / both values
<i>Defines which of the values, if any, must be cyclically retransmitted whenever activated.</i>		
Cyclic sending interval	Cyclic sending ≠ none	30 s / 1 min / 2 min / 3 min / 4 min / 5 min / 7 min / 10 min / 15 min / 20 min / 30 min / 45 min / 60 min / 90 min / 120 min
Interval between cyclical transmissions.		

Object name	Conditions	Dimens.	Flags	DPT	No. Comm. Obj.																
Pushbuttons (X) and (X+1) – switching command		1 Bit	CRWTU-	[1.001] switch	22, 54, 86, 118, 150, 182, 214, 246, 278, 310, 342, 374, 406, 438, 470, 502																
<i>Sends a command to a dimming actuator to switch the light on or off. The command is triggered by a short press on the input.</i>																					
Pushbuttons (X) and (X+1) – Dimming up / down / stop command		4 Bit	CR-T--	[3.007] dimming control, [3.008] blind control	23, 55, 87, 119, 151, 183, 215, 247, 279, 311, 343, 375, 407, 439, 471, 503																
<i>Sends a command to a dimming actuator to change dimming intensity (brighter or darker). Three values are used which mean start increase, start decrease or stop the change.</i>																					
<div style="text-align: center;"> <p>[3.007] Dimming 4 bit</p> <p>Bit number</p> <table style="margin: auto;"> <tr> <td style="border: 1px solid black; padding: 2px;">3</td> <td style="border: 1px solid black; padding: 2px;">2</td> <td style="border: 1px solid black; padding: 2px;">1</td> <td style="border: 1px solid black; padding: 2px;">0</td> </tr> </table> <p>Direzione: 0 = Aumenta, 1 = Diminuisce</p> <p>Ampiezza (001b...111b) o Stop (000b)</p> <div style="display: flex; justify-content: space-around; align-items: center;"> <div style="text-align: center;"> <p>Aumenta 100%</p> <table style="border-collapse: collapse;"> <tr> <td style="border: 1px solid black; padding: 2px;">1</td> <td style="border: 1px solid black; padding: 2px;">0</td> <td style="border: 1px solid black; padding: 2px;">0</td> <td style="border: 1px solid black; padding: 2px;">1</td> </tr> </table> </div> <div style="text-align: center;"> <p>Diminuisce 100%</p> <table style="border-collapse: collapse;"> <tr> <td style="border: 1px solid black; padding: 2px;">0</td> <td style="border: 1px solid black; padding: 2px;">0</td> <td style="border: 1px solid black; padding: 2px;">0</td> <td style="border: 1px solid black; padding: 2px;">1</td> </tr> </table> </div> </div> <div style="text-align: center; margin-top: 10px;"> <p>Stop</p> <table style="border-collapse: collapse;"> <tr> <td style="border: 1px solid black; padding: 2px;">0</td> <td style="border: 1px solid black; padding: 2px;">0</td> <td style="border: 1px solid black; padding: 2px;">0</td> <td style="border: 1px solid black; padding: 2px;">0</td> </tr> </table> </div> </div>						3	2	1	0	1	0	0	1	0	0	0	1	0	0	0	0
3	2	1	0																		
1	0	0	1																		
0	0	0	1																		
0	0	0	0																		
<i>Increase / decrease values are sent when a long press action occurs and stop value on press release.</i>																					
<i>The value sent can be a fixed value or it can be toggled at each input activation.</i>																					
<i>If the dimming command is used to control an actuator for shutters or blinds, the type of the used communication object is DPT 3.008 (blind control) whose values are "open" and "close".</i>																					

9.3.3.3 Shutter or venetian blind

This tab allows to link 2 pushbuttons to the commands for actuating a shutter or a venetian blind.

The following table shows the different modes of operation depending on the values chosen for the parameters.

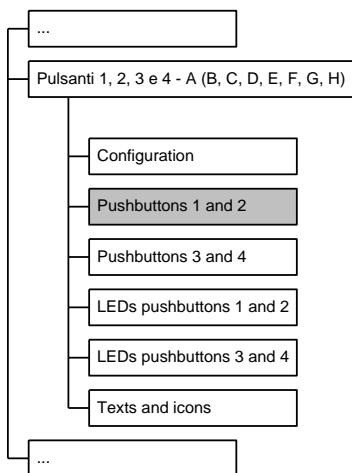

	Short press		Long press	
	Pushbutton (X)	Pushbutton (X+1)	Pushbutton (X)	Pushbutton (X+1)
Venetian blind mode disabled	Up until it stops	Down until it stops	stop if venetian blind is moving	
	Down until it stops	Up until it stops		
Venetian blind mode disabled	Opening step or stop	Closing step or stop	Up until it stops	Down until it stops
	Closing step or stop	Opening step or stop	Down until it stops	Up until it stops



In order to correctly define the result of the settings made with the following parameters, the placement selected with the "pushbutton pairing" parameter (horizontal or vertical) must be taken into account.

Pushbutton X tab shows the settings for shutters or blinds with the following conditions:

Configuration ⇒ *Pushbuttons X and next = Coupled*

Configuration ⇒ *Pushbutton X = Enabled*

Configuration ⇒ *Pushbutton X* ⇒ *Type = Shutter or venetian blind*

Parameter name	Conditions	Values
Lock function		disabled / enabled
Enables or disables the capability of locking the button through a remote command (telegram from bus). If this feature is enabled, a remote command can inhibit the pushbutton action or trigger shutter or venetian blind up or down movement in case of lock command activated or deactivated.		

Parameter name	Conditions	Values
Long press time		hh:mm:ss:ff (00:00:03:00)
	Minimum push time for a press in order to be recognized as a long press.	
Pushbuttons use		(X) increases, (X+1) decreases (X) decreases, (X+1) increases
	<i>Defines the action to be assigned to a long press. The short press action is automatically assigned to On / Off switching.</i>	
Venetian blind mode		disabled / enabled
	<i>If blinds mode is enabled, the device sends "full movement" telegrams on long press and "step" telegrams on short press; if it is disabled, the device sends "full movement" telegrams on long press and "stop" telegrams on short press.</i>	

Object name	Conditions	Dimens.	Flags	DPT	No. Comm. Obj.
Pushbuttons (X) and (X+1) – dedicated stop command	Venetian blind mode = disabled	1 Bit	CRWTU-	[1.017] trigger	22, 54, 86, 118, 150, 182, 214, 246, 278, 310, 342, 374, 406, 438, 470, 502
	<i>Immediately stops any movement of the blind. The object is sent on release after a long press (if the venetian blind mode is disabled).</i>				
Pushbuttons (X) and (X+1) – Stop-step up / down command	Venetian blind mode = enabled	1 Bit	CR-T--	[1.007] step	24, 56, 88, 120, 152, 184, 216, 248, 280, 312, 344, 376, 408, 440, 472, 504
	<i>Increases or decreases the opening of the blind stepwise, or interrupt an ongoing movement.</i>				
Pushbuttons (X) and (X+1) – up / down		1 Bit	CRWTU-	[1.008] up / down	25, 57, 89, 121, 153, 185, 217, 249, 281, 313, 345, 377, 409, 441, 473, 505
	<i>Moves the blind to fully open or fully closed position. The object is sent either on first press (if the venetian blind mode is disabled) or on long press (if the venetian blind mode is enabled).</i>				

9.3.3.4 Lock function

The lock function tab contains the parameters associated to the coupled pushbuttons in case of locking, unlocking and bus line recovery after a power supply failure. Lock is always determined by a communication object state updated by the bus. Both lock and unlock actions depend on the type of function associated to the coupled pushbuttons, such as send values or sequences, dimming, shutter or venetian blind command and scenes management.

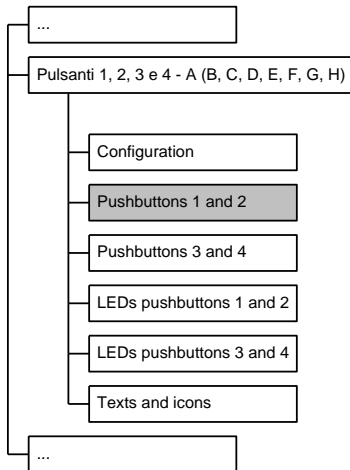

The *lock function* tab is active if:

Configuration ⇒ *Pushbuttons X and next = Coupled*

Configuration ⇒ *Pushbutton X = Enabled*

Parameter name	Conditions	Values
Invert lock device signal	Configuration -> Pushbutton X and next = coupled Pushbutton X and next -> Lock function = enabled	not inverted / inverted
	<i>Allows to interpret a "lock activate" telegram as unlock and vice-versa. This feature allows to bind the lock command to values of signals having an opposite polarity.</i>	
Lock after bus recovery	Configuration -> Pushbutton X and next = coupled Pushbutton X and next -> Lock function = enabled	no / yes
	<i>If active, after returning from a bus failure or power-off the device will retain the lock status it had before. Otherwise (in the default case), the device will restart in the non-locked condition.</i>	
Behavior at locking	Configuration -> Pushbutton X and next = coupled Pushbutton X and next -> Lock function = enabled Configuration -> Type = switching or dimming	none off on toggle
	<i>Specifies the behavior at locking when pushbutton X is configured as "dimming" type.</i>	

Parameter name	Conditions	Values
Behavior at unlocking	Configuration -> Pushbutton X and next = coupled Pushbutton X and next -> Lock function = enabled Configuration ->Type = switching or dimming	none off on as previous
<i>Specifies the behavior at unlocking when pushbutton X is configured as "dimming" type.</i>		
Behavior at locking	Configuration -> Pushbutton X and next = coupled Pushbutton X and next -> Lock function = enabled Configuration ->Type = shutter or venetian blind	none up down
<i>Specifies the behavior at locking when pushbutton X is configured as "shutter or venetian blind" type.</i>		
Behavior at unlocking	Configuration -> Pushbutton X and next = coupled Pushbutton X and next -> Lock function = enabled Configuration ->Type = shutter or venetian blind	none up down
<i>Specifies the behavior at unlocking when pushbutton X is configured as "shutter or venetian blind" type.</i>		

The following table shows the different option of behavior to locking and unlocking:

Function type	Behavior at locking	Behavior at unlocking
Switching	none off	none off
Dimming	on toggle	on as previous
Shutter or venetian blind	none up down	

Object name	Conditions	Dimens.	Flags	DPT	No. Comm. Obj.
Pushbuttons (X) and (X+1) – Lock command		1 Bit	C-W---	[1.003] enable	13, 45, 77, 109, 141, 173, 205, 237, 269, 301, 333, 365, 397, 429, 461, 493

9.3.4 LED pushbutton X and next

This tab contains the parameters allowing the configuration of the information that determines the on / off switching of the leds, i.e. fixed state or by pressing of the corresponding pushbutton or directly from bus. In addition, the tab allows you to configure the display mode of the leds, continuous or flashing.

The following parameters are intended to be repeated for each available led and do not depend on the pushbutton use (independent or coupled mode).

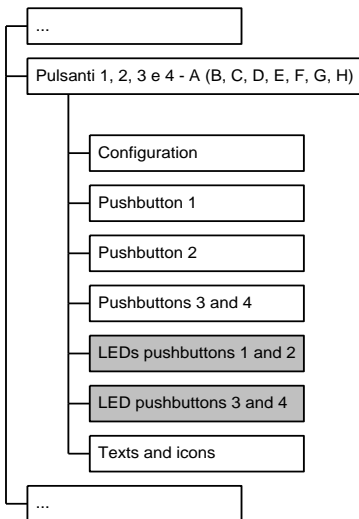

Led display in graphical pages is conditioned to the activation of the corresponding pushbutton, *Pushbutton tab* ⇒ *Configuration* ⇒ *Pushbuttons (X) ad (X+1)* = independent or coupled.

Please refer to *General* ⇒ *Led color (graphical pages)*³ for further informations about choosing the pair of led colors to display.

Parameter name	Conditions	Values
Led first color (X)		fixed / when contact closed / status from bus
	<i>Specifies whether the led has a fixed state, should be activated when the corresponding pushbutton is pressed, or should be activated through a communication object from the bus.</i>	
Off delay	Led first color (X) = when contact closed	hh:mm:ss:ff (00:00:02:00)
	<i>Delay before switching off after the associated pushbutton is no longer activated.</i>	
Always	Led first color LED (X) = fixed	off / on
	<i>Fixed status of the led.</i>	
Blinking	Led first color LED (X) = status from bus	no / yes
	<i>Determines the led display mode when the information comes from a communication object updated by the bus.</i>	

³ In 2.00 program version, the possibility to choose virtual leds colors related to graphical pushbuttons is predisposed but not implemented. First color is always green and second color is blue.

Parameter name	Conditions	Values
Signal from bus	Led first color (X) = status from bus	Not inverted / inverted
<p><i>Specifies whether the LED status from the bus should be inverted, i.e. LED on when an "off" command is received on the communication object.</i></p> <p><i>This feature is useful because the led status activation may be associated to a state-related communication object relative to the state of other entities with a reversed logic.</i></p>		
Blinking period / type	Led first color (X) = status from bus and blinking = yes	0,25 seconds on – 0,25 seconds off, 0,25 seconds on – 0,75 seconds off, 0,5 seconds on – 0,5 seconds off, 0,75 seconds on – 0,25 seconds off, 0,5 seconds on – 1,5 seconds off, 1 second on – 1 second off , 1,5 seconds on – 0,5 seconds off, 1 second on – 3 seconds off, 2 seconds on – 2 seconds off, 3 seconds on – 1 second off
<p><i>Specifies the duration of the "on" and "off" states for blinking.</i></p>		
Led second color (X)		fixed / when contact closed / status from bus
<p><i>Specifies whether the LED has a fixed state, should be activated when the corresponding pushbutton is pressed, or should be activated through a communication object from the bus.</i></p>		
Off delay	Led second color (X) = when contact closed	hh:mm:ss:ff (00:00:02:00)
<p><i>Delay before switching off after the associated pushbutton is no longer activated.</i></p>		
Always	Led second color LED (X) = fixed	off / on
<p><i>Fixed status of the led.</i></p>		
Blinking	Led second color LED (X) = status from bus	no / yes
<p><i>Determines the led display mode when the information comes from a communication object updated by the bus.</i></p>		
Signal from bus	Led second color (X) = status from bus	Not inverted / inverted
<p><i>Specifies whether the LED status from the bus should be inverted, i.e. LED on when an "off" command is received on the communication object.</i></p> <p><i>This feature is useful because the led status activation may be associated to a state-related communication object relative to the state of other entities with a reversed logic.</i></p>		
Blinking period / type	Led second color (X) = status from bus and blinking = yes	0,25 seconds on – 0,25 seconds off, 0,25 seconds on – 0,75 seconds off, 0,5 seconds on – 0,5 seconds off, 0,75 seconds on – 0,25 seconds off, 0,5 seconds on – 1,5 seconds off, 1 second on – 1 second off , 1,5 seconds on – 0,5 seconds off, 1 second on – 3 seconds off, 2 seconds on – 2 seconds off, 3 seconds on – 1 second off
<p><i>Specifies the duration of the "on" and "off" states for blinking.</i></p>		

Object name	Conditions	Dimens.	Flags	DPT	No. Comm. Obj.
Pushbutton X – led green command	Led first color (X) = status from bus	1 Bit	CRWTU-	[1.001] switch	41, 43, 73, 75, 105, 107, 137, 139, 169, 171, 201, 203, 233, 235, 275, 277, 307, 309, 339, 341, 371, 373, 403, 405, 435, 437, 467, 469, 499, 501, 531, 533
In 2.00 program version, the possibility to choose virtual leds colors related to graphical pushbuttons is predisposed but not implemented. First color is always green and second color is blue.					
Pushbutton X – led blue command	Led second color (X) = status from bus	1 Bit	CRWTU-	[1.001] switch	42, 44, 74, 76, 106, 108, 138, 140, 170, 172, 202, 204, 234, 236, 276, 278, 308, 310, 340, 342, 372, 374, 404, 406, 436, 438, 468, 470, 500, 502, 532, 534
See note above.					

9.3.5 Texts and icons

Following parameters are independent from how the pushbuttons are configured (as independent or coupled). The custom graphical elements associated with a pushbutton are only displayed if the corresponding pushbutton is enabled: *Pushbutton tab* ⇒ *Configuration* ⇒ *Pushbuttons (X) and (X+1)* = independent or coupled.

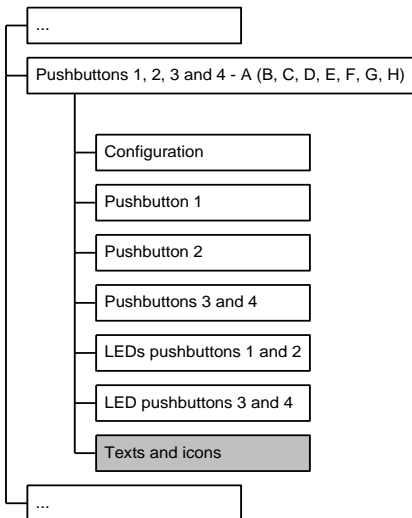

The maximum length of each text string is 28 characters in standard ASCII code. While planning the device configuration you must take into account that the strings are static, i.e. they do not change according to the general language setting of the device.



The device contains a comprehensive library of graphic symbols matching the style of those used in other exinex® wall mounted devices. For the choice of the most suitable icon or symbol, please refer to the Table of symbols listed in the Appendix.



Customized symbols can be displayed and selected in the selection boxes, after the corresponding images have been loaded in the device via SD card. For further information regarding images format and loading procedures please refer to the Customization chapter.

Parameter name	Conditions	Values
Text pushbutton (X)		ASCII text, max. 28 characters

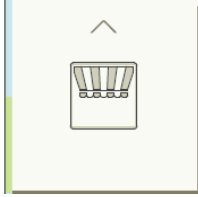
Parameter name	Conditions	Values
Text position pushbutton (X)		up / middle / down
<p data-bbox="630 309 1433 392"><i>Specifies the positioning of text on the surface of the pushbutton. The position of the text should not interfere with Icon #1 and Icon #2 in case the standard graphic symbols are also required.</i></p> <div data-bbox="928 398 1126 593" style="text-align: center;">  </div> <p data-bbox="630 600 1433 649"><i>For instance, in the above picture the custom text should be placed in the bottom position.</i></p>		

Parameter name	Conditions	Values
Icon 1 Pushbutton (X)		<p>00-no symbol, AA-buzzer, AB-electric load, AC-do not disturb, AD-garage door, AE-gate, Afbarrier, AG-pedestrian entrance AH-irrigation AI-floor lamp AL-wall lamp, AM-ceiling lamp, AN-spotlight, AO-staircase lighting, AP-outdoor lighting, AQ-lighting (generic), AR-dimming, AS-make up room, AT-sound system, AU-off, AV-on, AZ-shutter, venetian blinds, BA-indoor curtain, BB-outdoor curtain, BC-electric load mobile, BD-scene comfort, BE-scene irrigation, BF-lighting scene, BG-outdoor lighting scene, BH-scene manual, BI-scene night, BL-scene off, BM-scene on, BN-scene shutters up, BO-scene shutters down, BP-scene curtains up, BQ-scene curtains down, BR-scene party, BS-presence scene, BT-scene standby, BU-door lock, BV-unlock, BZ-lock, CA-room service, CB-service, CC-differently abled, CD-rescue, CE-loudspeaker, CF-temperature, CG-temperature increase, CH-temperature decrease, CI-fan, CL-Fans speed 1, CM-Fans speed 2, CN-Fans speed 3, CO-increase (solid arrow), CP-decrease (solid arrow), CQ-increase (empty arrow), CR-decrease (empty arrow), Icon01, Icon02, Icon03, Icon04, Icon05, Icon06, Icon07, Icon08</p>
<i>This icon is shown in the center position on the pushbutton surface and usually represents the main function of the pushbutton.</i>		

Parameter name	Conditions	Values
Icon 2 Pushbutton (X)		ZZ-no symbol, ZV-upper plus, ZU-lower plus, ZT-upper minus, ZS-lower minus, ZR-simple arrow up, ZQ-simple arrow down, ZP-empty arrow up, ZO-empty arrow down, ZN-solid arrow up, ZM-solid arrow down, ZL-upper empty circle, ZI-lower empty circle, ZH-upper solid circle, ZG-lower solid circle, ZF-upper triple empty circle, ZE-lower triple empty circle, ZD-upper triple solid circle, ZC-lower triple solid circle, ZB-left triple empty circle, ZA-right triple empty circle, VZ-left triple solid circle, VV-right triple solid circle
<i>This icon is shown in the top / bottom position on the pushbutton surface (or on the sides, according to configuration) and usually represents the actions of the pushbutton activation points.</i>		

10. Rocker configuration

10.1 Customization and online operation

This chapter describes the rockers configuration and it is valid only for EK-EF2-TP. Customization settings are equivalent to those adopted for “virtual” pushbuttons. Please refer to Chapter 9.1 for further information about the online operations that can be performed on the pushbutton, in particular: independent and coupled mode, send values or sequences, dimming, shutter or venetian blind command, scenes and lock function from bus.

10.1.1 Rocker use with independent functions, parallel and coupled pushbuttons

Each one of the two physical buttons is numbered, pushbutton 9 is positioned above in the frontal view and pushbutton 9 is below. Command events for functions A and B can be associated independently or in parallel: in the latter case, you can press on any point on the surface and a single command will be issued.

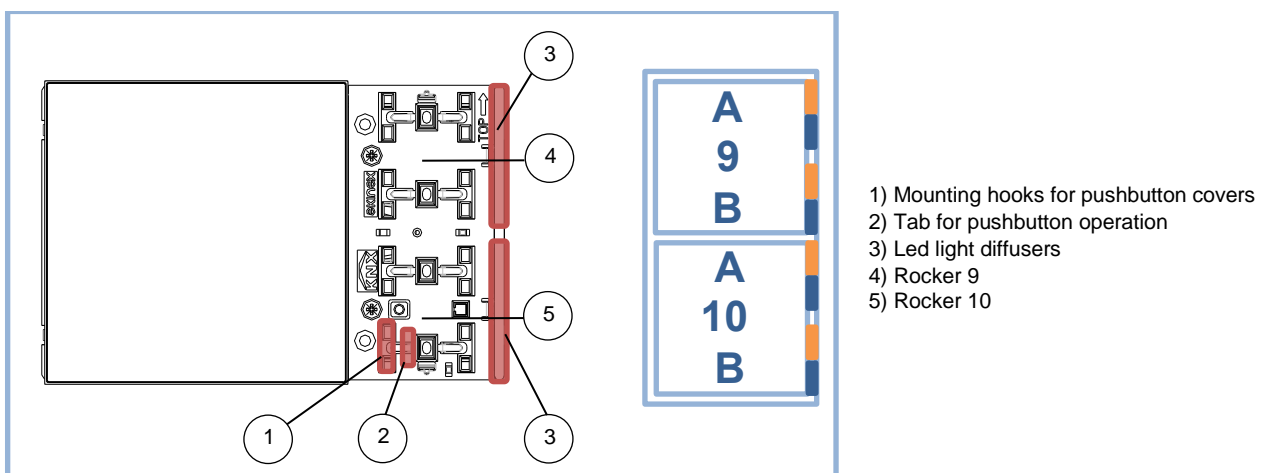

Alternatively, functions A and B of each rocker can be coupled. For example, function A opens the shutter and function B closes it. Anyway, since the configuration parameters is numbered, you must take into account the type of pairing chosen in order to avoid undesired functionalities.

10.1.2 Led rockers

Each rocker function is associated to 2 leds, similar to ekinex® KNX pushbuttons EK-EA2-TP and EK-EB2-TP. The led color combination (green / blue or red / white) can be chosen in order to coordinate the graphic interface with all pushbuttons in the building automation system. Leds can be individually configured even though the corresponding functions are coupled. The led activation can be configured in the following ways:

- Fixed value (led always on or always off);
- Led on when the corresponding rocker function is active. With this option, you can specify an additional led off delay after the pushbutton is released;
- State determined by the bus through a communication object. In this case, you can specify that, when condition is active, the led blinks (with different on / off time selection); furthermore, the on / off condition can be reversed compared to the state of the related communication object (led on object value is off and vice-versa).

10.2 Device settings

10.2.1 Rockers configuration

The *Rockers* tab is always active on EK-EF2-TP:

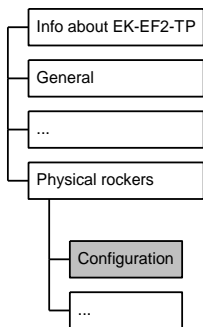

Parameter name	Conditions	Values
Rocker 9, functions A e B		disabled / independent / coupled
Function A	Rocker 9, functions A e B = independent	disabled / enabled
Type	Rocker 9, functions A e B = independent, Function A = enabled	send values or sequences dimming shutter or venetian blind scene
Function B		disabled / enabled / in parallel with function A, as a single function copy parameters from function A
	<i>By selecting the option "in parallel with function A, as a single function", the rocker will perform the same function no matter which point of the surface you will press. Otherwise, by selecting "copy parameters from function A" all the settings used for rocker 9A will be copied. The corresponding communication objects for rocker 9B will be activated in order to be connected to the introduced features.</i>	
Type	Rocker 9, functions A e B = independent, Function B = enabled	send values or sequences dimming shutter or venetian blind scene
Type	Rocker 9, functions A e B = coupled	switching / dimming / shutter or venetian blind
Rocker 10, functions A e B		disabled / independent / coupled / copy parameters from rocker 9
	<i>By selecting the option "copy parameters from rocker 9" all the settings used for coupled rocker 9 will be copied. The corresponding communication objects for rocker 10 will be activated in order to be connected to the introduced features.</i>	
Function A	Rocker 10, functions A e B = independent	disabled / enabled

Parameter name	Conditions	Values
Type	Rocker 10, functions A e B = independent, Function A = enabled	send values or sequences dimming shutter or venetian blind scene
Function B		disabled / enabled / in parallel with function A, as a single function copy parameters from function A
<p><i>By selecting the option "in parallel with function A, as a single function", the rocker will perform the same function no matter which point of the surface you will press. Otherwise, by selecting "copy parameters from function A" all the settings used for rocker 10A will be copied. The corresponding communication objects for rocker 10B will be activated in order to be connected to the introduced features.</i></p>		
Type	Rocker 10, functions A e B = independent, Function B = enabled	send values or sequences dimming shutter or venetian blind scene
Type	Rocker 10, functions A e B = coupled	switching / dimming / shutter or venetian blind

10.2.2 Rocker xA/B (independent mode)

10.2.2.1 Rocker xA/B: send values or sequences

This tab allows to send single telegrams or sequences of telegrams in correspondence of a short or long press relative to functions A and B of each rocker. This feature is very useful in many applications, because you can define sequences for up to 8 communication objects of different types and different short / long press values. If a single communication object is sent, it is also possible to configure the cyclic sending of one or both values.

Rocker xA/B tab is activated under the following conditions:

Configuration ⇒ Rocker x, functions A and B = independent

Configuration ⇒ Function A / B = enabled

Configuration ⇒ Type = send values or sequences

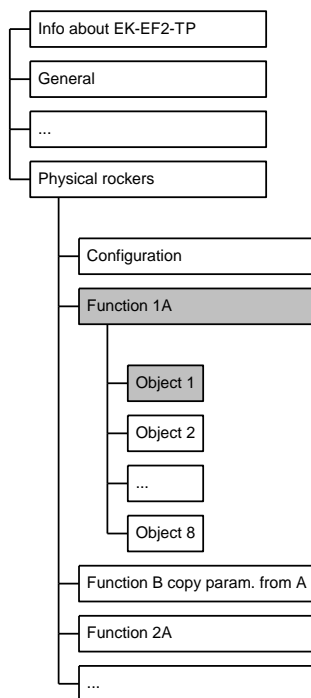

Based on the selected communication object number, Object X tabs are activated. Object X tabs allow to define the data type for each communication object and the reactions to the pushbutton press events.

Parameter name	Conditions	Values
Lock function		disabled / enabled
	Enables or disables the capability of locking the rocker through a remote command (telegram from bus). If this feature is enabled, a remote command can inhibit the rocker action or trigger the sending of values associated to a short / long press, in case of lock command activated or deactivated.	
Number of communication objects		1 (range from 1 to 8)
	Number of communication objects to associate to rocker events (short or long press).	
Event		activation / release short / long action

Parameter name	Conditions	Values
Long press time	Event = short / long action	hh:mm:ss:fff (00:00:03:000)
Minimum push time for a press in order to be recognized as a long press.		

10.2.2.2 Object X: send values or sequences

Parameter name	Conditions	Values
Send delay		hh:mm:ss:fff (00:00:00:000)
<i>Defines the command execution delay after a short or long press.</i>		
Send cyclically	Function xA/B ⇒ Number of communication objects = 1	none off / value 1 on / Value 2 both off and on / both values
<i>Cyclic sending option is active only if a single communication object is defined for the Function xA/B.</i>		
Cyclic sending interval	Function xA/B ⇒ Number of communication objects = 1 Cyclic sending ≠ none	hh:mm:ss (00:02:00)
<i>Cyclic sending option is active only if a single communication object is defined for the Function xA/B.</i>		
Communication Object dimension		1 bit value, 2 bit value, 1 byte unsigned value, 1 byte percentage, 1 byte signed value, 2 bytes unsigned value, 2 bytes signed value, 2 bytes floating value
Reaction to short press	Communication Object dimension = 1 bit value	none off on toggle
Reaction to long press	Communication Object dimension = 1 bit value	none off on toggle
Reaction to short press	Communication Object dimension = 2 bit value	none disable enable off / up enable on / down enable off up ⇔ disable enable on down ⇔ disable enable off up ⇔ enable on down
Reaction to long press	Communication Object dimension = 2 bit value	none disable enable off / up enable on / down enable off up ⇔ disable enable on down ⇔ disable enable off up ⇔ enable on down

Parameter name	Conditions	Values
Reaction to short press	Communication Object dimension = 1 byte unsigned value, 1 byte percentage, 1 byte signed value, 2 bytes unsigned value, 2 bytes signed value, 2 bytes floating value	none send value 1 send value 2 send value 1 ↔ send value 2
Reaction to long press	Communication Object dimension = 1 byte unsigned value, 1 byte percentage, 1 byte signed value, 2 bytes unsigned value, 2 bytes signed value, 2 bytes floating value	none send value 1 send value 2 send value 1 ↔ send value 2
Value 1	Communication Object dimension = 1 byte unsigned value, 1 byte percentage, 1 byte signed value, 2 bytes unsigned value, 2 bytes signed value, 2 bytes floating value	0 (0..255) 0 (0..100) 0 (-128..127) 0 (0..65535) 0 (-32768..32767) 0 (-671088,64..670760,96)
Value 2	Communication Object dimension = 1 byte unsigned value, 1 byte percentage, 1 byte signed value, 2 bytes unsigned value, 2 bytes signed value, 2 bytes floating value	0 (0..255) 0 (0..100) 0 (-128..127) 0 (0..65535) 0 (-32768..32767) 0 (-671088,64..670760,96)

Object name	Conditions	Dimens.	Flags	DPT	No. Comm. Obj.
Rocker xA/B – Switching status 1-bit object 1	Communication Object dimension = 1 bit value	1 Bit	CRWTU-	[1.001] switch	526, 540, 558, 572
<p><i>All addresses listed for the communication objects refer to Object 1 of each independent pushbutton. To identify Object n you need to sum (n-1) to the indicated address. Eg: Rocker 1 Function A, Object 4 has address 526 + (4-1) = 529</i></p>					

Object name	Conditions	Dimens.	Flags	DPT	No. Comm. Obj.		
Rocker xA/B – Switching status 2-bit object 1	Communication Object dimension = 2 bit value	2 Bit	CRWTU-	[2.001] switch control, [2.008] direction control 1	526, 540, 558, 572		
<p>2 bit</p> <p>Bit number</p> <table border="1" style="margin: auto;"> <tr> <td style="padding: 5px;">1</td> <td style="padding: 5px;">0</td> </tr> </table> <p>0 = off, 1 = on</p> <p>0 = No priority, 1 = Priority</p> <p><i>This communication object allows to force an output. The object consists of 2 bits: the less significant determines the command priority, the most significant determines the command status. Generally speaking, in case of a command without priority (no priority), the command value does not affect the actuator status to whom the command is issued.</i></p>						1	0
1	0						
Rocker xA/B – Switching status 1-unsigned byte object 1	Communication Object dimension = 1 byte unsigned value, 1 byte percentage	1 Byte	CRWTU-	[5.001] percentage (0..100%) [5.010] counter pulses (0..255)	526, 540, 558, 572		
Rocker xA/B – Switching status 1-signed byte object 1	Communication Object dimension = 1 byte signed value	1 Byte	CRWTU-	[6.001] percentage (-128..127%), [6.010] counter pulses (-128..127%)	526, 540, 558, 572		
Rocker xA/B – Switching status 2-unsigned bytes object 1	Communication Object dimension = 2 bytes unsigned value	2 Bytes	CRWTU-	[7.001] pulses	526, 540, 558, 572		
Rocker xA/B – Switching status 2-signed bytes object 1	Communication Object dimension = 2 bytes signed value	2 Bytes	CRWTU-	[8.001] pulses difference	526, 540, 558, 572		
Rocker xA/B – Switching status 2-bytes floating value object 1	Communication Object dimension = 2 bytes floating value	2 Bytes	CRWTU-	[9.xxx]	526, 540, 558, 572		

10.2.2.3 Rocker xA/B: dimming

This tab allows to link the commands for a dimming actuator (lighting device or blinds) to rocker functions A and B. A short press in simple mode can be associated to shutdown (closing) or power-up (opening); in toggle mode a short press automatically switches between off and on status. A long press, instead, can be associated to both increasing and decreasing of brightness (opening or closing).

The *Rocker xA/B* tab displays the parameters for dimming configuration with the following conditions:

Configuration ⇒ *Rocker x*, functions A and B = independent

Configuration ⇒ *Function A / B* = enabled

Configuration ⇒ *Type* = dimming

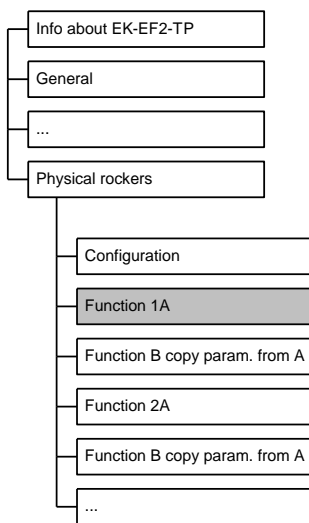

Parameter name	Conditions	Values
Lock function		disabled / enabled
	Enables or disables the capability of locking the rocker through a remote command (telegram from bus). If this feature is enabled, a remote command can inhibit the rocker action or trigger on or off state (or a toggle between the two states), in case of lock command activated or deactivated.	
Long press time		hh:mm:ss:ff (00:00:03:00)
	Minimum push time for a press in order to be recognized as a long press.	
Toggle mode		disabled / enabled
	<i>When enabled, causes the short press to toggle the on-off status of the destination CO; otherwise, a fixed status can be assigned to the short press.</i>	
Short / long action	Toggle mode = disabled	off / darker on / brighter off / (darker ↔ brighter) on / (darker ↔ brighter)
	Defines the function to be assigned to the long and short press.	
Reaction to long press	Toggle mode = enabled	darker brighter darker <-> brighter
	<i>Defines the function to be assigned to the long press. If the toggle mode is enabled, the Short press action is already defined as toggle.</i>	

Parameter name	Conditions	Values
Send cyclically		none off / Value 1 on / Value 2 both off and on / both values
<i>Defines which of the values, if any, must be cyclically retransmitted whenever activated.</i>		
Cyclic sending interval	Cyclic sending ≠ none	30 s / 1 min / 2 min / 3 min / 4 min / 5 min / 7 min / 10 min / 15 min / 20 min / 30 min / 45 min / 60 min / 90 min / 120 min
Interval between cyclical transmissions.		

Object name	Conditions	Dimens.	Flags	DPT	No. Comm. Obj.																
Rocker xA/B– Switching command		1 Bit	CRWTU-	[1.001] switch	534, 548, 566, 580																
<i>Sends a command to a dimming actuator to switch the light on or off. The command is triggered by a short press on the input. The value sent can be a fixed value or it can be toggled at each input activation.</i>																					
Rocker xA/B – Dimming up / down / stop command		4 Bit	CR-T--	[3.007] dimming control, [3.008] blind control	535, 549, 567, 581																
<i>Sends a command to a dimming actuator to change dimming intensity (brighter or darker). Three values are used which mean start increase, start decrease or stop the change.</i>																					
<div style="text-align: center;"> <p>[3.007] Dimming 4 bit</p> <p>Bit number</p> <table style="margin: auto;"> <tr> <td style="border: 1px solid black; padding: 2px;">3</td> <td style="border: 1px solid black; padding: 2px;">2</td> <td style="border: 1px solid black; padding: 2px;">1</td> <td style="border: 1px solid black; padding: 2px;">0</td> </tr> </table> <p>Direzione: 0 = Aumenta, 1 = Diminuisce</p> <p>Ampiezza (001b...111b) o Stop (000b)</p> </div> <div style="display: flex; justify-content: space-around; margin-top: 10px;"> <div style="text-align: center;"> <p>Aumenta 100%</p> <table style="margin: auto;"> <tr> <td style="border: 1px solid black; padding: 2px;">1</td> <td style="border: 1px solid black; padding: 2px;">0</td> <td style="border: 1px solid black; padding: 2px;">0</td> <td style="border: 1px solid black; padding: 2px;">1</td> </tr> </table> </div> <div style="text-align: center;"> <p>Diminuisce 100%</p> <table style="margin: auto;"> <tr> <td style="border: 1px solid black; padding: 2px;">0</td> <td style="border: 1px solid black; padding: 2px;">0</td> <td style="border: 1px solid black; padding: 2px;">0</td> <td style="border: 1px solid black; padding: 2px;">1</td> </tr> </table> </div> </div> <div style="text-align: center; margin-top: 10px;"> <p>Stop</p> <table style="margin: auto;"> <tr> <td style="border: 1px solid black; padding: 2px;">0</td> <td style="border: 1px solid black; padding: 2px;">0</td> <td style="border: 1px solid black; padding: 2px;">0</td> <td style="border: 1px solid black; padding: 2px;">0</td> </tr> </table> </div>						3	2	1	0	1	0	0	1	0	0	0	1	0	0	0	0
3	2	1	0																		
1	0	0	1																		
0	0	0	1																		
0	0	0	0																		
<i>Increase / decrease commands are sent after a long press; stop is sent when the rocker is released.</i>																					
<i>The value sent can be a fixed value or it can be toggled at each input activation.</i>																					
<i>If the dimming command is used to control an actuator for shutters or blinds, the type of the used communication object is DPT 3.008 (blind control) whose values are "open" and "close".</i>																					

10.2.2.4 Rocker xA/B: shutter or venetian blind

This tab allows to link a rocker functions A and B to the commands for actuating a shutter or a venetian blind.

The following table shows the different modes of operation depending on the values chosen for the parameters.

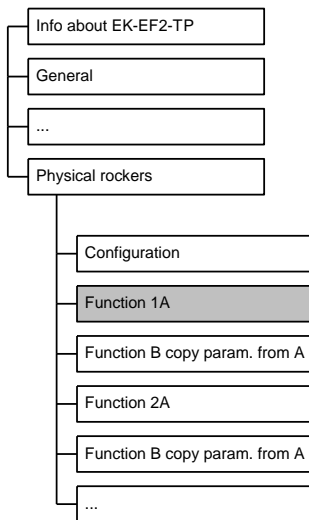

	Short press		Long press	
	Toggle disabled	Toggle enabled	Toggle disabled	Toggle enabled
Venetian blind mode disabled	up until it stops down until it stops	alternatively up or down until it stops	stop se venetian blind is moving	
Venetian blind mode enabled	opening step or stop closing step or stop	alternatively opening or closing step or stop	up until it stops down until it stops	alternatively up or down until it stops

The *Rocker xA/B* tab shows the settings for shutters or blinds with the following conditions:

Configuration ⇒ *Rocker x*, *functions A and B* = independent

Configuration ⇒ *Function A / B* = enabled

Configuration ⇒ *Type* = shutter or venetian blind

Parameter name	Conditions	Values
Lock function		disabled / enabled
	Enables or disables the capability of locking the rocker Function A / B through a remote command (telegram from bus). If this feature is enabled, a remote command can inhibit the rocker action or trigger shutter or venetian blind up or down movement in case of lock command activated or deactivated.	
Long press time		hh:mm:ss:ff (00:00:03:00)
	Minimum push time for a press in order to be recognized as a long press.	
Toggle mode		disabled / enabled
	<i>When enabled, consecutive short presses reverse the direction of movement is reversed; otherwise, a constant value (up or down) is associated to a short press.</i>	
Up / down action	Toggle mode = disabled	down / up
	Defines the direction of movement associated to the rocker press.	

Parameter name	Conditions	Values
Venetian blind mode		disabled / enabled
<p><i>If blinds mode is enabled, the device sends "full movement" telegrams on long press and "step" telegrams on short press; if it is disabled, the device sends "full movement" telegrams on long press and "stop" telegrams on short press.</i></p>		

Object name	Conditions	Dimens.	Flags	DPT	No. Comm. Obj.
Rocker xA/B – dedicated stop command	Venetian blind mode = disabled	1 Bit	CRWTU-	[1.017] trigger	534, 548, 566, 580
<p><i>Immediately stops any movement of the blind. The object is sent on release after a long press (if the venetian blind mode is disabled).</i></p>					
Rocker xA/B – Stop-step up / down command	Venetian blind mode = enabled	1 Bit	CR-T--	[1.007] step	536, 550, 568, 582
<p><i>Increases or decreases the opening of the blind stepwise, or interrupt an ongoing movement.</i></p>					
Rocker xA/B – up / down		1 Bit	CRWTU-	[1.008] up / down	537, 551, 569, 583
<p><i>Moves the blind to fully open or fully closed position. The object is sent either on first press (if the venetian blind mode is disabled) or on long press (if the venetian blind mode is enabled).</i></p>					

10.2.2.5 Rocker xA/B: scene

This tab allows to link a short press of the rocker to a scene recall or a toggle mode recall of two alternative scenes. It is also possible to set the learning mode: in this case, after a short press a scene is recalled, while after a long press the device sends a telegram allowing to save the state associated to the corresponding scene.

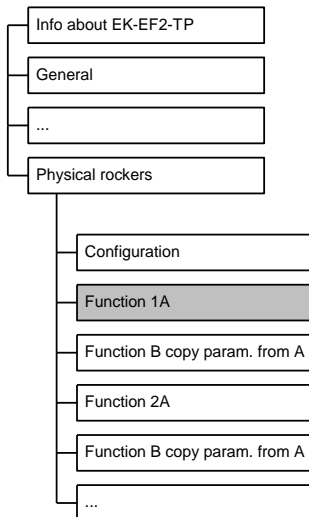

The *Rocker xA/B* scene tab shows the scene configuration parameters if:

Configuration ⇒ *Rocker x*, functions A and B = independent

Configuration ⇒ *Function A / B* = enabled

Configuration ⇒ Type = scene

Parameter name	Conditions	Values
Lock function		disabled / enabled
	Enables or disables the capability of locking the rocker function A / B through a remote command (telegram from bus). If this feature is enabled, a remote command can inhibit the rocker action or trigger two alternative scenes in case of lock command activated or deactivated.	
First scene number		1..63 (1)
	<i>Main scene number to be assigned to rocker press. It is named "first" for the case that an alternative scene number is used.</i>	
Learning mode		disabled / enabled
	<i>When enabled, a long rocker press can be used to program the selected scene by storing the current parameters.</i>	
Long press time	Learning mode = enabled	hh:mm:ss:ff (00:00:03:000)
	Minimum push time for a press in order to be recognized as a long press.	
Scene activation	Learning mode = disabled	Send first scene only, toggle between 2 scenes
	<i>Allows the rocker to be used to alternate between two different scenes.</i>	
Second scene number	Scene activation = toggle between 2 scenes	1..63 (2)
	Alternate scene number to be assigned to rocker press.	

Object name	Conditions	Dimens.	Flags	DPT	No. Comm. Obj.
Rocker xA/B – scene number		1 Byte	CRWTU-	[17.001] scene number, [18.001] scene control	538, 552, 570, 584

Saves or recalls a scene.

The lowest 6 bits in the byte form the code of the scene, while the highest bit is the operation code (save or recall).

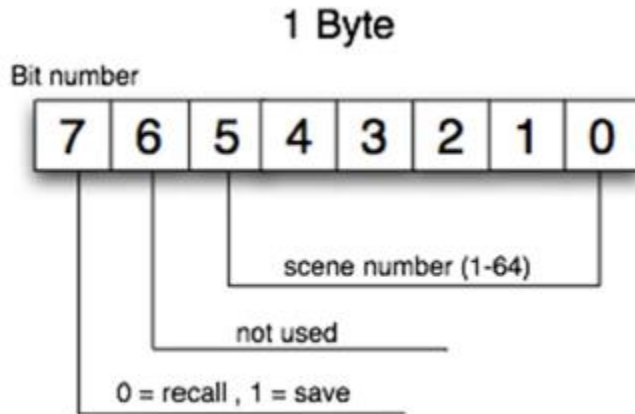

10.2.2.6 Lock function

The lock function tab contains the parameters associated to the actions associated to the functions A and B in case of locking, unlocking and bus line recovery after a power supply failure. Lock is always determined by a communication object state updated by the bus. Both lock and unlock actions depend on the type of function associated to the functions A and B of the independent rockers, such as values or sequences sending, dimming, blinds or venetian blinds command and scenes management.

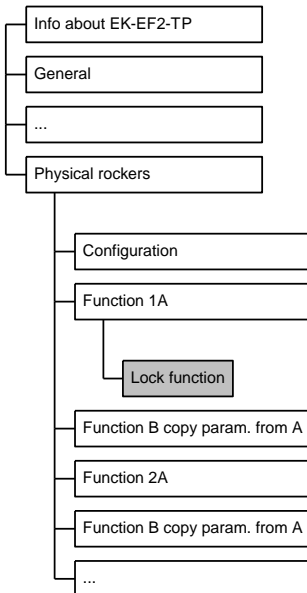

The *lock function* tab is active if:

Configuration ⇒ *Rocker x*, *functions A and B* = independent

Configuration ⇒ *Function A / B* = enabled

Rocker xA/B ⇒ *Lock function* = enabled

Parameter name	Conditions	Values
Invert lock device signal	Configuration -> Rocker xA/B = enabled Rocker xA/B -> Lock function = enabled	not inverted / inverted
	<i>Allows to interpret a "lock activate" telegram as unlock and vice-versa, for example: device lock active when an "off" command through communication object is received. This feature allows to bind the lock command to values of signals having an opposite polarity.</i>	
Lock after bus recovery	Configuration -> Rocker xA/B = enabled Rocker xA/B -> Lock function = enabled	no / yes
	<i>If active, after returning from a bus failure or power-off the device will retain the lock status it had before. Otherwise (in the default case), the device will restart in the unlocked condition.</i>	

Parameter name	Conditions	Values
Behavior at locking	Configuration -> Rocker xA/B = enabled Rocker xA/B -> Lock function = enabled Configuration ->Type= send values or sequences	none / come chiudere or short press / come aprire or long press
	<i>Specifies the behavior at locking when rocker xA/B is configured as "send values or sequences".</i>	
Behavior at unlocking	Configuration -> Rocker xA/B = enabled Rocker xA/B -> Lock function = enabled Configuration ->Type= send values or sequences	none / come chiudere or short press / come aprire or long press
	<i>Specifies the behavior at unlocking when rocker xA/B is configured as "send values or sequences".</i>	
Behavior at locking	Configuration -> Rocker xA/B = enabled Rocker xA/B -> Lock function = enabled Configuration ->Type= dimming	none off on toggle
	<i>Specifies the behavior at locking when rocker xA/B is configured as "dimming".</i>	
Behavior at unlocking	Configuration -> Rocker xA/B = enabled Rocker xA/B -> Lock function = enabled Configuration ->Type= dimming	none off on as previous
	<i>Specifies the behavior at unlocking when rocker xA/B is configured as "dimming".</i>	
Behavior at locking	Configuration -> Rocker xA/B = enabled Rocker xA/B -> Lock function = enabled Configuration ->Type= shutter or venetian blind	none up down
	<i>Specifies the behavior at locking when rocker xA/B is configured as "shutter or venetian blind".</i>	
Behavior at unlocking	Configuration -> Rocker xA/B = enabled Rocker xA/B -> Lock function = enabled Configuration ->Type= shutter or venetian blind	none up down
	<i>Specifies the behavior at unlocking when rocker xA/B is configured as "shutter or venetian blind".</i>	
Behavior at locking	Configuration -> Rocker xA/B = enabled Rocker xA/B -> Lock function = enabled Configuration ->Type= scene	none send first scene send second scene
	<i>Specifies the behavior at locking when rocker xA/B is configured as "scene" type. The numbers associated to the first and second scene are those selected in the rocker xA/B tab. To activate this behavior at locking, you need to disable the scene learning mode for rocker xA/B.</i>	

Parameter name	Conditions	Values
Behavior at unlocking	Configuration -> Rocker xA/B = enabled Rocker xA/B -> Lock function = enabled Configuration ->Type= scene	none send primo scene send second scene
<i>Specifies the behavior at unlocking when rocker xA/B is configured as "scene" type. The numbers associated to the first and second scene are those selected in the rocker xA/B tab. To activate this behavior at locking, you need to disable the scene learning mode for rocker xA/B.</i>		

The following table shows the different option of behavior to locking and unlocking:

Function type	Behavior at locking	Behavior at unlocking
Send values or sequences	none as close or short press as open or long press	
Dimming	none off on toggle	none off on as previous
Shutter or venetian blind	none up down	
Scene	none send first scene send second scene	

Object name	Conditions	Dimens.	Flags	DPT	No. Comm. Obj.
Rocker xA/B – Lock command		1 Bit	C-W---	[1.003] enable	525, 539, 557, 571

10.2.3 Rocker x, Functions A and B coupled

10.2.3.1 Switching

This tab allows to link two coupled pushbuttons to 2 states of a binary 1-bit command. This feature does not make a difference between short and long press.

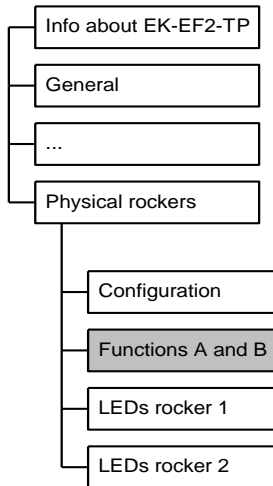

The *Functions A and B* tab shows the switching configuration parameters with the following conditions:

Configuration ⇒ *Rocker x, Functions A and B* = coupled

Configuration ⇒ *Type* = switching

Parameter name	Conditions	Values
Lock function		disabled / enabled
	Enables or disables the capability of locking the rockers through a remote command (telegram from bus). If this feature is enabled, a remote command can inhibit the rockers action or trigger the on / off state (or a toggle between the two states) in case of lock command activated or deactivated.	
xA and xB use		(X) on, (X+1) off (X) off, (X+1) on
	Defines the state of the binary command to pair to each rocker.	
Send cyclically		none off / value 1 on / value 2 both off and on / both values
	Defines which of the values, if any, must be cyclically retransmitted whenever activated.	
Cyclic sending interval	Cyclic sending ≠ none	30 s / 1 min / 2 min / 3 min / 4 min / 5 min / 7 min / 10 min / 15 min / 20 min / 30 min / 45 min / 60 min / 90 min / 120 min
	Interval between cyclical transmissions.	

Object name	Conditions	Dimens.	Flags	DPT	No. Comm. Obj.
Rocker (x) – switching command		1 Bit	CRWTU-	[1.001] switch	534, 548, 566, 580

10.2.3.2 Dimming

This tab allows to link the commands for a dimming actuator (lighting device or blinds) to rocker functions A and B. Each function A or B can be associated to shutdown (short press) and decreasing of brightness (long press), or power-up (short press) and increasing of brightness (long press).

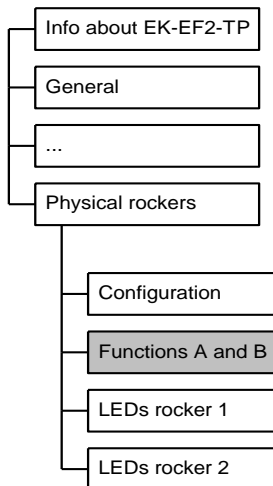

The *Functions A and B* tab shows the dimming configuration parameters with the following conditions:

Configuration ⇒ *Rocker x, Functions A and B* = coupled

Configuration ⇒ Type = dimming

Parameter name	Conditions	Values
Lock function		disabled / enabled
	Enables or disables the capability of locking the rockers through a remote command (telegram from bus). If this feature is enabled, a remote command can inhibit the rockers action or trigger the on / off state (or a toggle between the two states) in case of lock command activated or deactivated.	
Long press time		hh:mm:ss:ff (00:00:03:000)
	Minimum push time for a press in order to be recognized as a long press.	
Pushbuttons use		A increases, B decreases A decreases, B increases
	<i>Defines the action to be assigned to a long press. The short press action is automatically assigned to On / Off switching.</i>	
Send cyclically		none off / value 1 on / value 2 both off and on / both values
	<i>Defines which of the values, if any, must be cyclically retransmitted whenever activated.</i>	
Cyclic sending interval	Cyclic sending ≠ none	30 s / 1 min / 2 min / 3 min / 4 min / 5 min / 7 min / 10 min / 15 min / 20 min / 30 min / 45 min / 60 min / 90 min / 120 min
	Interval between cyclical transmissions.	

Object name	Conditions	Dimens.	Flags	DPT	No. Comm. Obj.																
Rocker (x) – Switching command		1 Bit	CRWTU-	[1.001] switch	534, 566																
Sends a command to a dimming actuator to switch the light on or off. The command is triggered by a short press on the input.																					
Rocker (x) – Dimming up / down / stop command		4 Bit	CR-T--	[3.007] dimming control, [3.008] blind control	535, 567																
Sends a command to a dimming actuator to change dimming intensity (brighter or darker). Three values are used which mean start increase, start decrease or stop the change.																					
<p>[3.007] Dimming 4 bit</p> <div style="display: flex; justify-content: space-around; align-items: flex-start;"> <div style="text-align: center;"> <p>Bit number</p> <table border="1" style="border-collapse: collapse;"> <tr> <td style="padding: 2px 10px;">3</td> <td style="padding: 2px 10px;">2</td> <td style="padding: 2px 10px;">1</td> <td style="padding: 2px 10px;">0</td> </tr> </table> <p style="font-size: small;">Direzione: 0 = Aumenta, 1 = Diminuisce</p> <p style="font-size: small;">Ampiezza (001b...111b) o Stop (000b)</p> </div> <div style="text-align: center;"> <p>Aumenta 100%</p> <table border="1" style="border-collapse: collapse;"> <tr> <td style="padding: 2px 10px;">1</td> <td style="padding: 2px 10px;">0</td> <td style="padding: 2px 10px;">0</td> <td style="padding: 2px 10px;">1</td> </tr> </table> </div> <div style="text-align: center;"> <p>Diminuisce 100%</p> <table border="1" style="border-collapse: collapse;"> <tr> <td style="padding: 2px 10px;">0</td> <td style="padding: 2px 10px;">0</td> <td style="padding: 2px 10px;">0</td> <td style="padding: 2px 10px;">1</td> </tr> </table> </div> <div style="text-align: center; margin-top: 10px;"> <p>Stop</p> <table border="1" style="border-collapse: collapse;"> <tr> <td style="padding: 2px 10px;">0</td> <td style="padding: 2px 10px;">0</td> <td style="padding: 2px 10px;">0</td> <td style="padding: 2px 10px;">0</td> </tr> </table> </div> </div> <p>Increase / decrease commands are sent after a long press; stop is sent when the rocker is released.</p> <p>The value sent can be a fixed value or it can be toggled at each input activation.</p> <p>If the dimming command is used to control an actuator for shutters or blinds, the type of the used communication object is DPT 3.008 (blind control) whose values are "open" and "close".</p>						3	2	1	0	1	0	0	1	0	0	0	1	0	0	0	0
3	2	1	0																		
1	0	0	1																		
0	0	0	1																		
0	0	0	0																		

10.2.3.3 Shutter or venetian blind

This tab allows to link the functions A and B to the commands for actuating a shutter or a venetian blind.

The following table shows the different modes of operation depending on the values chosen for the parameters.

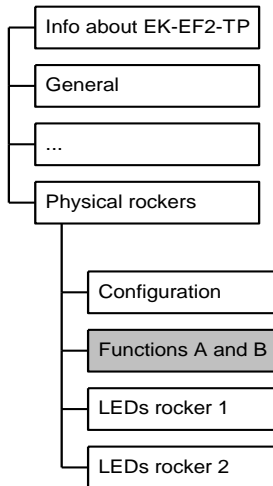

	Short press		Long press	
	Pushbutton (X)	Pushbutton (X+1)	Pushbutton (X)	Pushbutton (X+1)
Venetian blind mode disabled	Up until it stops	Down until it stops	stop if venetian blind is moving	
	Down until it stops	Up until it stops		
Venetian blind mode disabled	Opening step or stop	Closing step or stop	Up until it stops	Down until it stops
	Closing step or stop	Opening step or stop	Down until it stops	Up until it stops

The *Functions A and B* tab shows the settings for shutters or blinds with the following conditions:

Configuration ⇒ *Rocker x, Functions A and B* = coupled

Configuration ⇒ *Type* = shutter or venetian blind

Parameter name	Conditions	Values
Lock function		disabled / enabled
	Enables or disables the capability of locking the rockers through a remote command (telegram from bus). If this feature is enabled, a remote command can inhibit the rockers action or trigger shutter or venetian blind up or down movement in case of lock command activated or deactivated.	
Long press time		hh:mm:ss:ff (00:00:03:00)
	Minimum push time for a press in order to be recognized as a long press.	
Pushbuttons use		A up, B down A down, B up
	<i>Defines the action to be assigned to a long press. The short press action is automatically assigned to On / Off switching.</i>	

Parameter name	Conditions	Values
Venetian blind mode		disabled / enabled
<p><i>If blinds mode is enabled, the device sends "full movement" telegrams on long press and "step" telegrams on short press; if it is disabled, the device sends "full movement" telegrams on long press and "stop" telegrams on short press.</i></p>		

Object name	Conditions	Dimens.	Flags	DPT	No. Comm. Obj.
Rocker (x) – dedicated stop command	Venetian blind mode = disabled	1 Bit	CRWTU-	[1.017] trigger	534, 566
<p><i>Immediately stops any movement of the blind. The object is sent on release after a long press (if the venetian blind mode is disabled).</i></p>					
Rocker (x) – Stop-step up / down command	Venetian blind mode = abilitato	1 Bit	CR-T--	[1.007] step	536, 568
<p><i>Increases or decreases the opening of the blind stepwise, or interrupt an ongoing movement.</i></p>					
Rocker (x) – up / down		1 Bit	CRWTU-	[1.008] up / down	537, 569
<p><i>Moves the blind to fully open or fully closed position. The object is sent either on first press (if venetian blind mode is disabled) or on long press (if venetian blind mode is enabled).</i></p>					

10.2.3.4 Lock function

The lock function tab contains the parameters that set the actions associated to the rocker functions A and B in case of locking, unlocking and bus line recovery after a power supply failure. Lock is always determined by a communication object state updated by the bus. Both lock and unlock actions depend on the type of function associated to the rockers, such as values or sequences sending, dimming, blinds or venetian blinds command and scenes management.

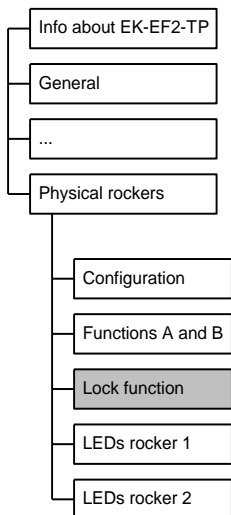

The *lock function* tab is active if:

Configuration ⇒ *Rocker x, Functions A and B = coupled*

Functions A and B ⇒ *Lock function = enabled*

Parameter name	Conditions	Values
Invert lock device signal	Configuration -> Rocker (x), functions A and B = coupled Functions A and B -> Lock function = enabled	not inverted / inverted
	<i>Allows to interpret a "lock activate" telegram as unlock and vice-versa. This feature allows to bind the lock command to values of signals having an opposite polarity.</i>	
Lock after bus recovery	Configuration -> Rocker (x), functions A and B = coupled Functions A and B -> Lock function = enabled	no / yes
	<i>If active, after returning from a bus failure or power-off the device will retain the lock status it had before. Otherwise (in the default case), the device will restart in the non-locked condition.</i>	
Behavior at locking	Configuration -> Rocker (x), functions A and B = coupled Functions A and B -> Lock function = enabled Configuration ->Type= switching or dimming	none off on toggle
	<i>Specifies the behavior at locking when rocker X is configured as "dimming" type.</i>	

Parameter name	Conditions	Values
Behavior at unlocking	Configuration -> Rocker (x), functions A and B = coupled Functions A and B -> Lock function = enabled Configuration ->Type= switching or dimming	none off on as previous
<i>Specifies the behavior at unlocking when rocker X is configured as "dimming" type.</i>		
Behavior at locking	Configuration -> Rocker (x), functions A and B = coupled Functions A and B -> Lock function = enabled Configuration ->Type= shutter or venetian blind	none up down
<i>Specifies the behavior at locking when rocker X is configured as "shutter or venetian blind" type.</i>		
Behavior at unlocking	Configuration -> Rocker (x), functions A and B = coupled Functions A and B -> Lock function = enabled Configuration ->Type= shutter or venetian blind	none up down
<i>Specifies the behavior at unlocking when rocker X is configured as "shutter or venetian blind" type.</i>		

The following table shows the different option for locking and unlocking behavior.

Function type	Behavior at locking	Behavior at unlocking
Switching	none	none
Dimming	off on toggle	off on as previous
Shutter or venetian blind	none up down	

Object name	Conditions	Dimens.	Flags	DPT	No. Comm. Obj.
Rocker (x) – Lock command		1 Bit	C-W---	[1.003] enable	525, 557

10.2.4 LED Rocker x

This tab contains the parameters allowing the configuration of the information that determines the on / off switching of the leds, i.e. fixed state or by pressing of the corresponding pushbutton or directly from bus. In addition, the tab allows you to configure the display mode of the leds, continuous or flashing.

The following parameters are intended to be repeated for each available led and do not depend on the rockers functions A and B use.

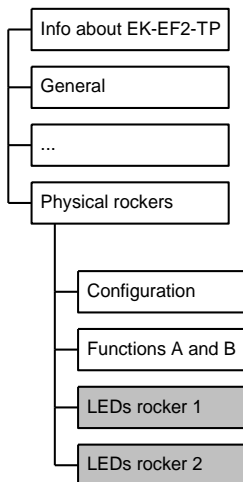

The led rocker x tabs are always active in version EK-EF2-TP. Pairings between first and second color can be, for example, green / blue or red / white. For further information about available color pairings you need to specify the excurtainsd product code.

Parameter name	Conditions	Values
First color LED xA / xB		fixed / when contact closed / status from bus
	<i>Specifies whether the led has a fixed state, should be activated when the corresponding pushbutton is pressed, or should be activated through a communication object from the bus.</i>	
Off delay	Led first color xA / xB = when contact closed	hh:mm:ss:ff (00:00:02:00)
	<i>Delay before switching off after the associated rocker is no longer activated.</i>	
Always	Led first color xA / xB = fixed	off / on
	<i>Fixed status of the led.</i>	
Blinking	Led first color xA / xB = status from bus	no / yes
	<i>Determines the led display mode when the information comes from a communication object updated by the bus.</i>	
Signal from bus	Led first color xA / xB = status from bus	not inverted / inverted
	<i>Specifies whether the LED status from the bus should be inverted, i.e. led on when an "off" command is received on the communication object. This feature is useful because the led status activation may be associated to a state-related communication object relative to the state of other entities with a reversed logic.</i>	

Parameter name	Conditions	Values
Blinking period / type	Led first color xA / xB = status from bus and Blinking = yes	0,25 seconds on – 0,25 seconds off, 0,25 seconds on – 0,75 seconds off, 0,5 seconds on – 0,5 seconds off, 0,75 seconds on – 0,25 seconds off, 0,5 seconds on – 1,5 seconds off, 1 second on – 1 second off , 1,5 seconds on – 0,5 seconds off, 1 second on – 3 seconds off, 2 seconds on – 2 seconds off, 3 seconds on – 1 second off
<i>Specifies the duration of the “on” and “off” states for blinking.</i>		
Second color LED xA / xB		fixed / contact closed / status from bus
<i>Specifies whether the led has a fixed state, should be activated when the corresponding pushbutton is pressed, or should be activated through a communication object from the bus.</i>		
Off delay	Led second color xA / xB = when contact closed	hh:mm:ss:ff (00:00:02:00)
<i>Led off delay when the rocker is released.</i>		
Always	Led second color xA / xB = fixed	off / on
<i>Fixed status of the led.</i>		
Blinking	Led second color xA / xB = status from bus	no / yes
<i>Determines the led display mode when the information comes from a communication object updated by the bus.</i>		
Signal from bus	Led second color xA / xB = status from bus	not inverted / inverted
<i>Specifies whether the led status from the bus should be inverted, i.e. LED on when an “off” command is received on the communication object. This feature is useful because the led status activation may be associated to a state-related communication object relative to the state of other entities with a reversed logic.</i>		
Blinking period / type	Led second color xA / xB = status from bus and Blinking = yes	0,25 seconds on – 0,25 seconds off, 0,25 seconds on – 0,75 seconds off, 0,5 seconds on – 0,5 seconds off, 0,75 seconds on – 0,25 seconds off, 0,5 seconds on – 1,5 seconds off, 1 second on – 1 second off , 1,5 seconds on – 0,5 seconds off, 1 second on – 3 seconds off, 2 seconds on – 2 seconds off, 3 seconds on – 1 second off
<i>Specifies the duration of the “on” and “off” states for blinking.</i>		

Object name	Conditions	Dimens.	Flags	DPT	No. Comm. Obj.
Rocker (x) – led first color A	Led first color xA	1 Bit	CRWTU-	[1.001] switch	553, 585
Rocker (x) – led second color A	Led second color xA	1 Bit	CRWTU-	[1.001] switch	554, 586
Rocker (x) – led first color B	Led first color xB	1 Bit	CRWTU-	[1.001] switch	555, 587
Rocker (x) – led second color B	Led second color xB	1 Bit	CRWTU-	[1.001] switch	556, 588

11. Zone ambient chronothermostat configuration

11.1 Online operations

11.1.1 External sensors

The Touch&See unit controls the ambient temperature of 8 independent zones, each one with its own time scheduling.

In version EK-EF2-TP (with integrated temperature sensor), zone 1 can be configured to directly control ambient temperature by using the internal sensor; the measured value can also be weighted through an arithmetic average with additional 4 ambient temperature values acquired from the bus. Otherwise, for zones from 2 to 8 in version EK-EF2-TP and for all the 8 zones in version EK-EC2-TP, the regulation is performed only by acquiring values from the bus through communication objects. Up to 4 additional sensors for each zone can be configured and the device performs an arithmetic average between all considered values, allowing to effectively filter local perturbations e.g. from heat sources. The ekinex® EK-EA2-TP and EK-EB2-TP pushbutton units are equipped with an integrated temperature sensor; they are therefore an ideal complement to be used together with the Touch&See unit. To this purpose, it is crucial that the pushbutton units used for sensing be mounted on non-perimetral walls at a minimal height of 1.5 m from the floor.

An internal timeout on bus reception of temperature data guarantees that the control algorithms are correctly performed; if a required value has not been received within the timeout period, it is excluded from the computation for the average value. If none of the values from the configured sensors is received, the control algorithm gives up control; an alarm is issued, which is shown on the side bar of the screen pages and recorded with the time stamp of the time and date when the failure occurred.

The currently measured value for ambient temperature is displayed at the top of the side bar and is therefore visible in all the main pages.

When the thermostatic functions are enabled, one value for relative humidity and one for the air quality (CO₂ concentration) can be acquired through communication objects; these data are only used for display in the chronothermostat page. Relative humidity can optionally be acquired with a 1-Byte (DPT 5.001) or 2-Byte (DPT 9.007) format; CO₂ concentration has a 2-Byte format (DPT 9.008) in ppm (parts per million) units.

11.1.2 Applications

The chronothermostat is suitable for following applications:

- radiators, electrical heaters and radiant floors, with following output control options:
 - 2-point with hysteresis, On-Off type output;
 - Proportional-Integral, On-Off type or PWM continuous output
- fan coils, with following output control options:
 - On-Off fan control with 1 to 3 stages;
 - continuous fan speed control
 - control of 2-pipe or 4-pipe systems

11.1.3 Control algorithms

The picture below shows the components of a common generic control system for ambient temperature. The room thermostat measures the actual temperature of the air mass and constantly compares it to the setpoint value⁴.

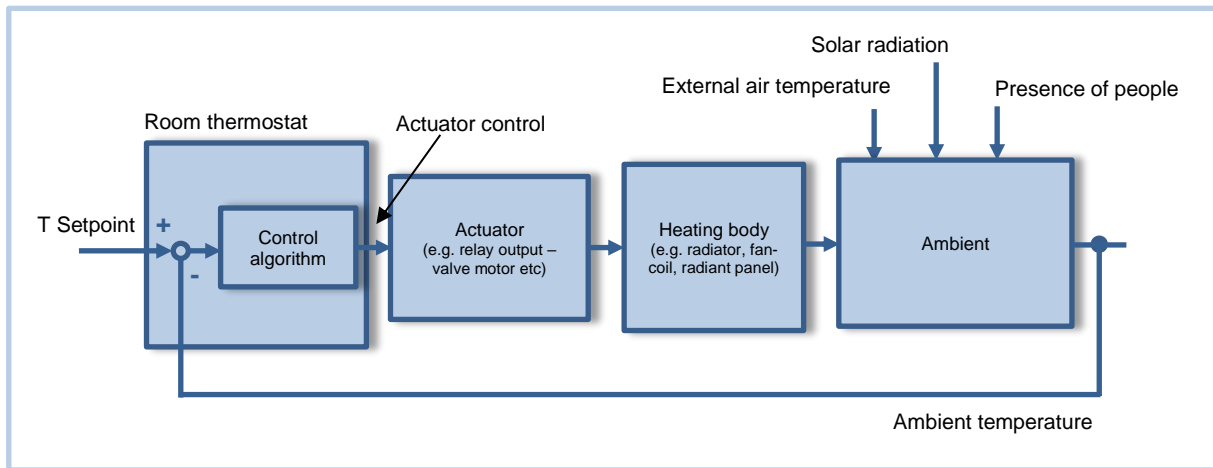

The control algorithm, basing on the difference between the setpoint and measured temperature values, processes a command value which can be of analog or On / Off type; the command is represented by a CO that is transmitted via bus, either periodically or event based, to a KNX actuator device.

The output of the actuator device is the driving variable of the control system, which can be e.g. a flow rate of water or air. The control system realized by the room thermostat is of feedback type, namely the algorithm takes into account the effects on the system in order to change the control action on the same entity.

The device offers following temperature control algorithms:

- Two-point control with hysteresis
- Continuous P-I controller (with analogue output)
- Continuous P-I controller with PWM output

These algorithms will be detailed in the following sections.

11.1.3.1 Two-point control with hysteresis

This control algorithm, which is also known as On / Off, is the most classic and popular. The control provides for the on / off switching of the system following a hysteresis loop, i.e. two threshold levels are considered for the switching instead of a single one.

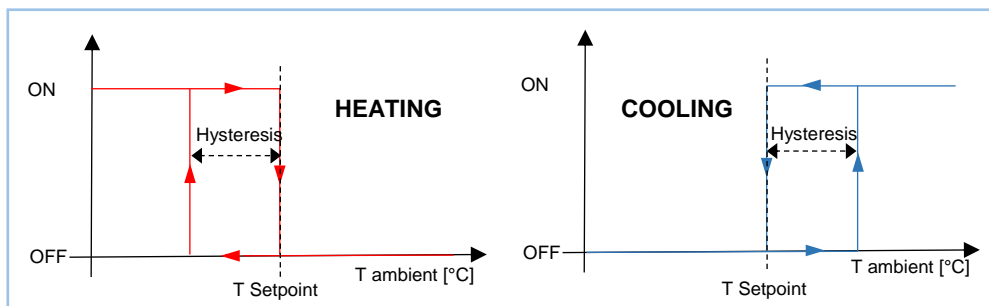

Heating mode: when the measured temperature is lower than the value of the difference [Setpoint - Hysteresis], whereby “Hysteresis” identifies the differential adjustment of the boilers, the device activates the heating system by sending a message or KNX telegram to the actuator that handles the heating system;

⁴ Throughout this manual, the terms “desired value” or “setpoint value” are used interchangeably.

when the measured temperature reaches the desired temperature (Setpoint), the device disables the heating system by sending another message. In this way, there are two decision thresholds for activation and deactivation of the heating, the first being the level [Setpoint - hysteresis] below which the device activates the system, whereas the second is the desired temperature above which the heating system is deactivated.

Cooling mode: When the measured temperature is higher than the value of the difference [Setpoint - Hysteresis], the device activates the air conditioning system by sending a message or KNX telegram to the actuator that handles it; when the measured temperature falls below the desired temperature (Setpoint), the device turns off the air conditioning system by sending another message.

In the ETS application program, two different parameters are available for the hysteresis value for heating and cooling: the values usually differ depending on the system type and its inertia.

In order to optimize energy saving⁵, the value of the desired temperature setting can be made to vary between different values, depending on several types of events which are set during configuration or selected by the user:

- manual corrections of the desired temperature;
- hourly or daily scheduling;
- forcing of the operating mode by an external supervisor device;
- presence of people;
- opening of windows or doors.

11.1.3.2 Continuous Proportional-Integral control

The continuous proportional-integral (P-I) controller uses an analog control variable to modulate the output of the heating – cooling system.

A detailed explanation of the P-I controller and its parameters is supplied in the appendix section; it will be assumed that the reader is familiar with the parameters described therein.

The ETS application program allows to set following parameter combination when continuous mode is selected:

Terminal type	Proportional band [K]	Integral time [min]
Radiators	5	150
Electrical heaters	4	100
Fan-coils	4	90
Floor radiant panels	5	240
Other type	Custom [0 ... 25.5]	Custom [0 ... 255]

The following are guidelines for the choice of parameters for a proportional-integral regulator.

- **Cycle time:** The cycle time should be chosen at least one order of magnitude (10 times) higher than the approximate characteristic time constants of the ambient; for systems with low inertia, such as air convection heating and cooling, short periods (10-15 min or lower, compatibly with the capabilities and performance of the heating / cooling system) should be chosen to avoid wide fluctuations in temperature.

⁵ For each additional degree of room temperature, the energy dispersion towards the outside environment - and consequently also the energy consumption - increases by approximately 6%

- **Proportional Band:** a narrow P.B. yields quick settling time to setpoint, but broad and continuous fluctuations in ambient temperature. A wide P.B, conversely, yields small to practically no oscillations of ambient temperature, but a slightly larger settling time.
- **Integral time:** a short I.T. yields short settling time but continuous oscillations around the setpoint; a long I.T. yields longer settling time but no oscillations.

11.1.3.3 PWM-output Proportional-Integral control

The proportional-integral PWM (Pulse Width Modulator) controller uses an analog control variable to modulate the duration of the time intervals in which a binary output is in the On or Off state. The controller operates in a periodic manner over a cycle, and in each period it maintains the output to the On value for a time proportional to the value of the control variable. As shown in the figure, by varying the ratio between the ON time and the OFF time, the average time of activation of the output varies, and consequently the average intake of heating or cooling power supplied to the environment.

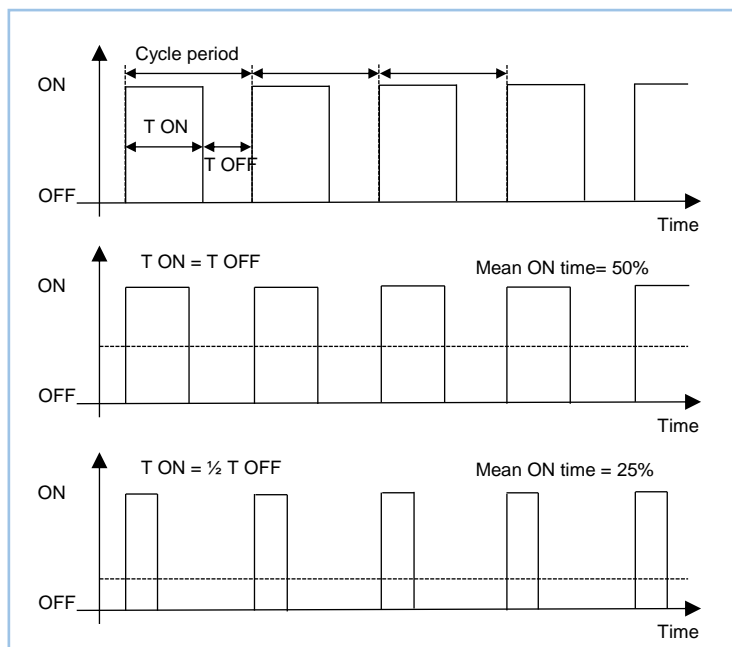

This type of controller is well suited for use with On / Off type actuators, such as relays and actuators for zone valves, which are less expensive (both for electrical and mechanical components) than proportional actuators. A distinctive advantage of this type of controller, compared with the raw On / Off controller already described, is that it eliminates the inertia characteristics of the system: it allows significant energy savings, because you avoid unnecessary interventions on the system introduced by the 2-point control with hysteresis and it only provides the power required to compensate for losses in the building.

Every time the user or the supervisor changes the desired temperature setpoint, the cycle time is interrupted, the control output is reprocessed and the PWM restarts with a new cycle: this allows the system to reach its steady state more quickly.

It must be highlighted that this type of controller is still based on an analog control block such as the P-I regulator just described (or possibly other analog regulator blocks): the difference lies entirely in the regulator output stage. As a matter of fact, the PWM regulator can be described as an analog controller followed by an analog-to-PWM output converter stage:

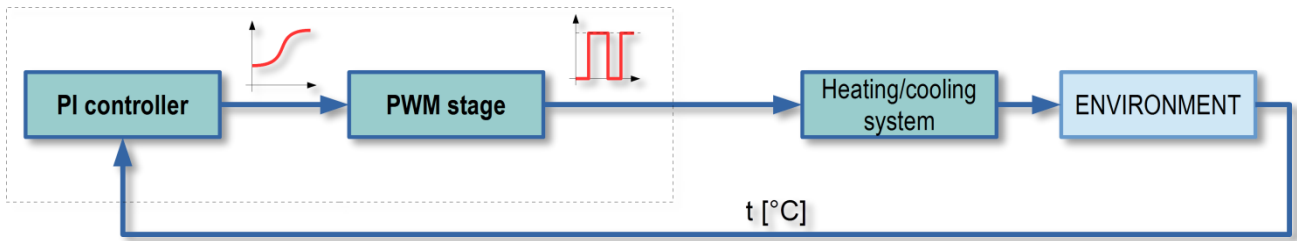

If the characteristic time constant (i.e. inertia) of the controlled system is large enough compared to the PWM, it can be considered to inherently act as an effective low-pass filter for the controlled variable; therefore, the presence of the PWM output stage can be practically ignored from a control point of view.

The ETS application program, in addition to the parameters relating to the P-I part of the controller (already described in the previous paragraph), allows to choose the duration of the cycle period (from 5 to 240 min) for the PWM part. For systems with low inertia, such as air-convected heating and conditioning, short periods (10-15 min) should be chosen in order to avoid excessive fluctuations in temperature.

11.1.3.4 Fan-coils with On / Off fan speed control

The multi-stage fan control is similar to the 2-point control with hysteresis described in the previous section. The speed of the fan is chosen basing on the difference between the set point and the actual measured temperature. The substantial difference from the described 2-points algorithm is that, in this case, there can be up to three stages (depending the number of available fan speeds); a different hysteresis threshold exists for each stage transition.

At a given stage, i.e. speed setting, a threshold causes the switching to a higher speed (or none, for the highest stage) while the other causes the switching to a lower speed (or off, for the lowest stage). Usually, but not inherently, a same threshold value will be used for both transitions that lead to each speed from the adjacent ones.

Following pictures should help clarify the mechanism:

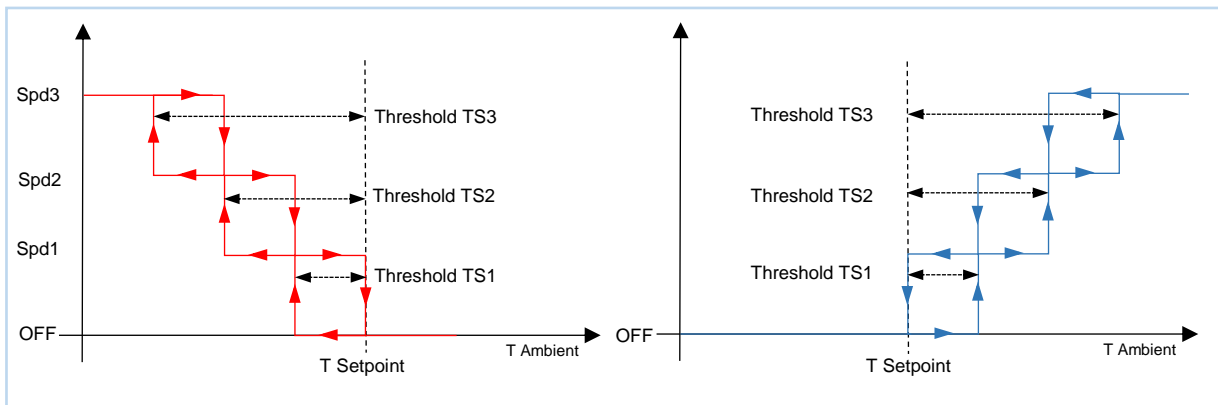

The left diagram refers to the speed control of the fan-coil (with 3-stage operation) in heating mode.

Note that the thresholds are always expressed in terms of the Setpoint Temperature; a further threshold level exists which is not highlighted in the picture, that is, Threshold TS0, at level $T = T_{setpoint}$ (i.e. $T_{setpoint} - T_{threshold} = 0$).

The thresholds values are specified in the ETS application program, and their effect can be summarized as follows:

Speed (Stage)	Activated when	Deactivated when
1	$T_{setpoint} - T_{threshold} > TS1$	$T_{setpoint} - T_{threshold} < 0$
2	$T_{setpoint} - T_{threshold} > TS2$	$T_{setpoint} - T_{threshold} < TS1$
3	$T_{setpoint} - T_{threshold} > TS3$	$T_{setpoint} - T_{threshold} < TS2$

The right part of the diagram refers to the system in cooling mode; the operation is very similar, so it will not be described in details.

The transition between speeds is guaranteed to occur in such a way that the control lines for all speeds other than the selected one are deactivated before switching is performed.

The more comprehensive case of a 3-speed fan is described above; options for 2-speed or 1-speed fans, for which the operation is completely similar, are also available.

It should be noted that in applications where both heating and cooling modes are active, the thresholds of the speeds are the same in the two modes of operation.

11.1.3.5 Fan-coil with continuous speed control

In this type of control, the output speed level can assume values expressed as a percentage (1 Byte - DPT 5.001 percentage).

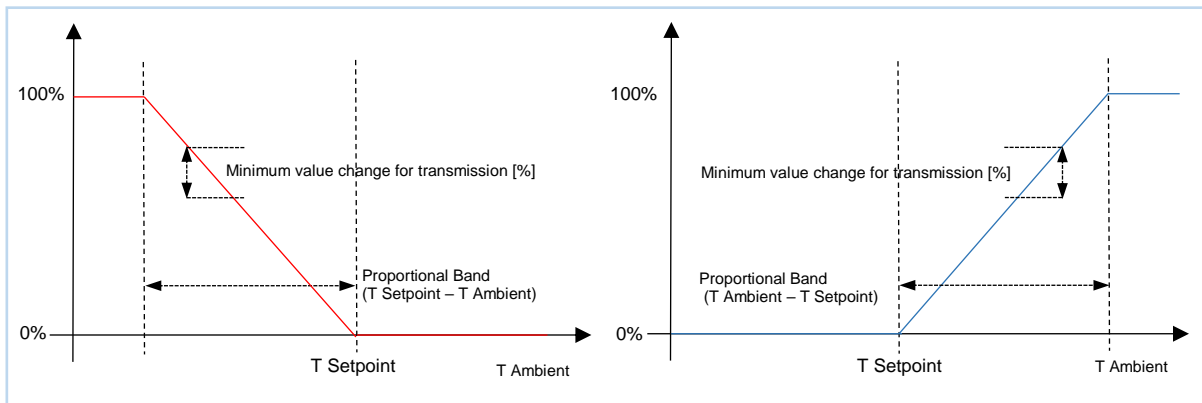

The ETS application program provides the Proportional Band parameter that takes the same value for both heating and cooling: this parameter determines the proportionality of the intervention of the fan.

A further parameter is the minimal change in the control value (in %) required to trigger its transmission on the bus; this allows to limit the generated bus traffic.

11.1.3.6 Control for auxiliary heating / cooling system

Some heating / cooling systems, such as the radiant floor panels (with the exclusion of the so called "dry" versions, in which the water circuits are not embedded in a concrete slab), show a very large response inertia; this is mostly due to the fact that a relevant part of building mass is involved in the thermal exchange.

In order to improve response time for start-up or ambient temperature transients, auxiliary systems with substantially lower inertia are used in support of the main system whenever the difference between setpoint and measured temperatures becomes significant.

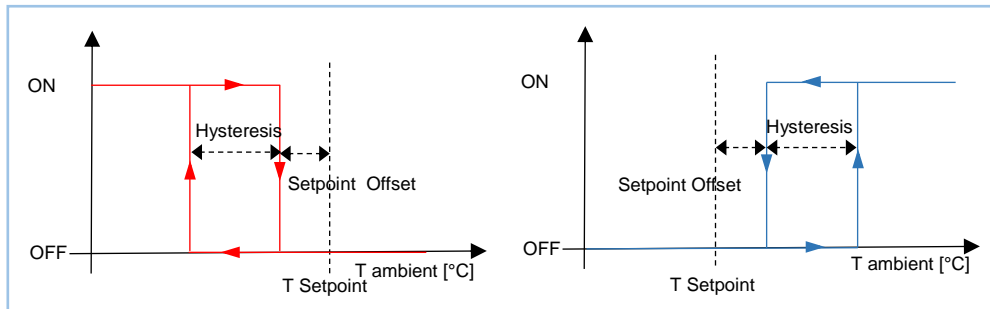

The auxiliary – also called “second-tier” – system, in the initial stage, contributes to heat / cool the environment and then stops its action when the difference between the setpoint and the measured temperature is lower and can be addressed by the system with higher inertia.

The control algorithm used for the second-tier system is the 2-point On / Off control with hysteresis.

As usual, only the operation in Heating mode will be described; the Cooling mode operation is the same but reversed.

When the measured temperature is lower than the value of the lower threshold (Desired temperature - Setpoint Offset - hysteresis), the device activates the auxiliary heating; when the rising measured temperature reaches the value of the higher threshold (Desired temperature - Setpoint Offset), the auxiliary heating system is turned off.

11.1.4 Operating modes

The Touch&See unit has four predefined operating modes:

- comfort;
- standby;
- economy;
- building protection.

Each of these operating modes identifies a different temperature setpoint (for heating; there is a separate setpoint set for cooling), which can be assigned through the ETS program.



Comfort



Economy



Standby



Building protection
(anti-ice or overheating protection)

Each of these setpoints is accessible through communication objects (except in automatic mode); the setpoints can therefore be changed locally through the user interface (refer to the chapter describing the user interface) or remotely via the communication objects. The only exception is represented by the building protection setpoint, which can not be modified locally by the user: this parameter is related to the safe operation in the protection of system components (particularly in heating mode). This parameter must therefore be configured in advance through ETS or can be changed, if necessary, by another supervisor device via the bus.

11.1.5 Daily – weekly scheduler

The internal daily – weekly scheduler can be programmed to perform a setpoint switching between two operating modes at the programmed times of day.

The choices of operating modes that can be associated with the scheduler are

- comfort and standby
- comfort and economy

The alternation between comfort and standby modes is more suited for rooms with frequent occupancy and / or with control systems having a large inertia; vice-versa, an alternation between comfort and economy modes is more suited for spaces with infrequent presence and / or low-inertia control systems.

Seven different hourly profiles, labeled P1 to P7, are available; each of them can be assigned to one or several week days.

Each hourly profile contains up to 3 comfort-mode periods, each with a definable starting and ending time of day; outside of these periods, the other operating mode is set according to configuration.

The setpoint value which has been set according to the program schedule may be temporarily modified by the end user (limited to a configurable deviation) through the chronothermostat page of the user interface. The mode of operation can also be temporarily changed by the user; the modification lasts until the next mode change event triggered by the scheduler. For details about how to perform these changes, please refer to the section of the manual dedicated to the user interface.

Several features can have influence on the value of the current operating mode: the following table lists them in order of priority (higher first).

Window open contact
HVAC mode forcing
Presence detection
Hourly scheduler
(User setting)

The override status is visible in the sideband of each screen, where the text indicating the current operating mode is displayed flashing.

The currently programmed mode can also be sent to other devices on the bus that should act as "slaves" via a communication object.

11.1.6 Seasonal mode switching (Heating / Cooling)

The switch between heating and cooling mode can take place in 3 ways:

1. manually, by user command, through the corresponding screen page;
2. automatically, through a command from the internal logic of the device;
3. automatically, through a command from the KNX bus.

Manual switching

Mode 1 is suitable for installations with a small number of temperature control devices installed. If the devices have been configured for this purpose, the user performs the switching manually on the display panel of the

Touch & See ("master" unit for switching); the device transmits on the bus the output communication object which provides for the switching of other thermostats ("slave" appliances) connected with the matching group address.

Switching through internal logic

Mode 2 is suitable for applications with heating / cooling systems with a 4-pipe configuration (e.g. fan-coils or radiant ceiling panels). Also in this case the information can be transmitted on the bus through an output communication object; the difference with respect to the manual mode is that the switching is performed automatically by the machine, basing on the values of current temperature and setpoint. In this mode, the manual switching by the user is inhibited.

The automatic switching is achieved by introducing a dead band as shown in the following figure.

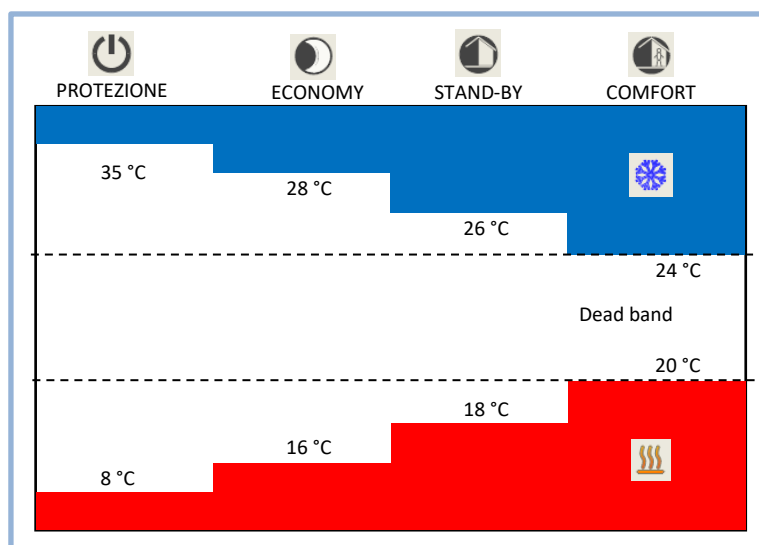

The figure shows that, as long as the actual measured temperature below the heating mode setpoint, the heating mode is selected; similarly, if the value is greater than the cooling setpoint, then cooling mode is selected. If the value is within the dead band, the operation mode remains unchanged until the value itself passes over the threshold value associated with the opposite mode.



In order to avoid inconsistencies between the different configured temperature levels, unlike in other switching mechanisms, the values of the 4 + 4 threshold levels are not exposed through communication objects.

A single communication object is made available (which corresponds to the comfort setpoint in heating mode): all other values are consistently computed according to the value of this single parameter.

Switching through a KNX telegram

In Mode 3, the switching command comes from the KNX bus, i.e. from another "master" KNX device, such as a room thermostat. The Touch & See unit in this case behaves as a "slave" appliance: the switching takes place by means of an input communication object. In this mode, manual switching by the user is inhibited.

11.1.7 Window switch management

Window switch management is an optional feature, oriented to energy saving, which becomes available only if the chrono-thermostat function is enabled.

Whenever a condition of opened window is detected, the operating mode is forced to “building protection “ and it remains forced as long as the open window condition is active. The program provides a time delay parameter for detection, in order to discriminate between an occasional short-term opening (e.g. to provide air exchange in the room) from an unintentional opening that justifies the power-saving function to be recalled.

The operating mode determined from Window switch management has priority on all operating mode settings imposed by the scheduler, by the presence detection feature and by external forcing through an HVAC supervisor.

The physical detection of window openings is normally performed through KNX-interfaced switches; their output should consist of 1-bit communication objects that should be matched with the corresponding objects in the *Touch&See*. These can be of any polarity (On when opened or On when closed); they are evaluated with an internal logical OR operation, so that the activation of any single contact triggers the window open condition.

11.1.8 Presence detection

The presence or occupancy detection function includes a set of optional features, aimed at energy saving, which become available only if the chrono-thermostat function is enabled.

The physical detection of presence is normally performed through KNX-interfaced sensors; their output should consist of 1-bit communication objects that should be matched with the corresponding objects in the *Touch&See*. These can be of any polarity (On when presence is detected or On when NO presence is detected); the configured communication objects are evaluated with an internal logical OR operation, so that the activation of any single sensor triggers the presence detection.

As a general operating mode, the presence detection can be used to extend the duration of the “*Comfort*” mode period if (and for only as long as) people are present in a room, or vice versa to bring the end of the period forward in case no people are present. The resulting possibilities are the following three: extension of the comfort period, shortening of the comfort period, or their combination. These possibilities will be described in the following paragraphs.

Extension of the comfort period.

The function is only active if the current mode is *Comfort*; if during this period presence is detected, the operating mode remains set on *Comfort* even if either the hourly scheduler or the user request to change mode to *Economy* or *Standby*. Once presence is not detected for a period longer than a configurable time, the operation mode requested by the scheduler is restored.

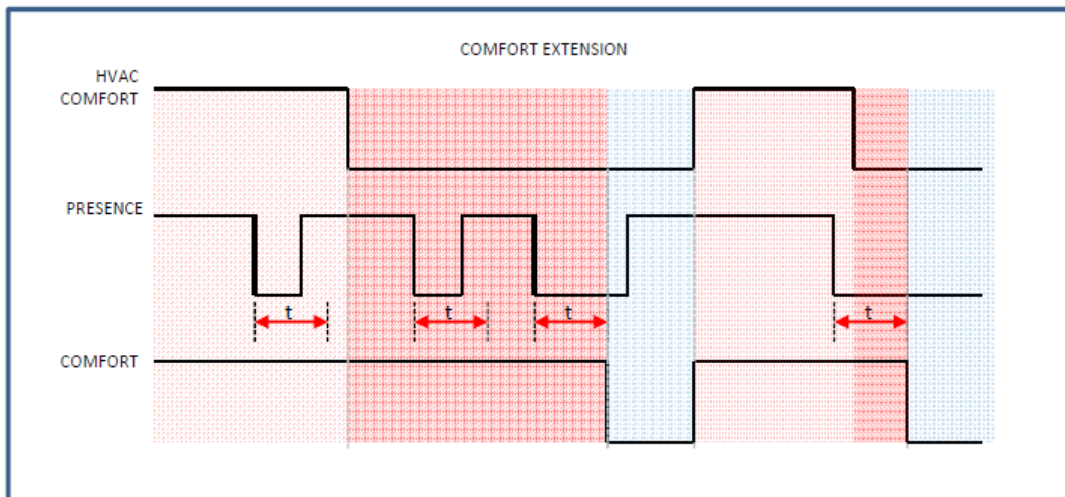

The diagram shows that, even if it is presence is detected during a period in which the operating mode set by the scheduler is not *Comfort*, no mode change happens until the next mode switch to *Comfort* requested by the scheduler.

As previously illustrated in the priority table, if external mode forcing is used, this has priority over the mode requested by the presence detection; in turn, window opening maintains precedence over all other mode transition mechanisms.

Shortening of the comfort period.

The function is only active if the current mode is *Comfort*; if, during this period, no presence is detected for a time longer than a configured duration, the operating mode is changed to either *Standby* or *Economy* as chosen. The destination mode can be configured independently from the mode used for the hourly scheduler.

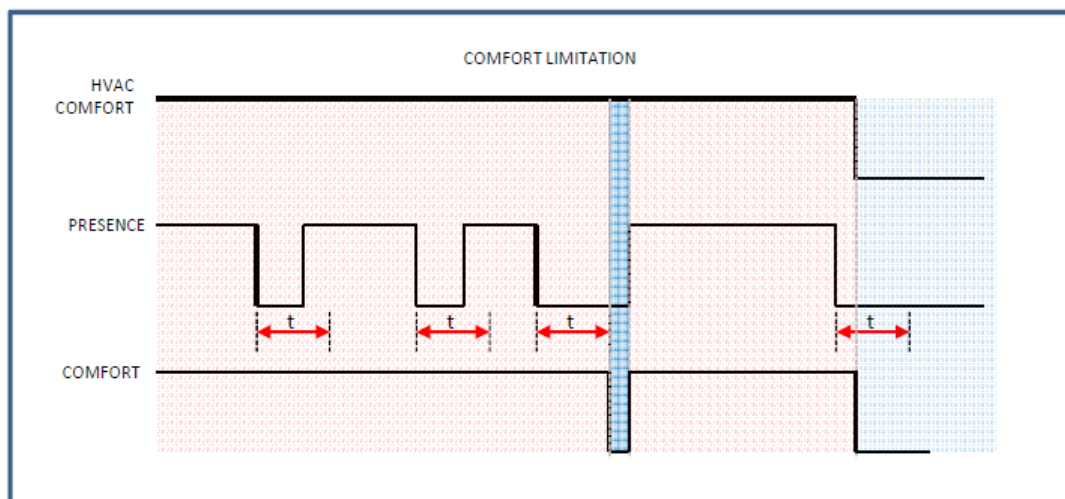

As previously illustrated in the priority table, if external mode forcing is used, this has priority over the mode requested by the presence detection; in turn, window opening maintains precedence over all other mode transition mechanisms.

Extension and shortening of the comfort period.

This mode is a combination of the previous two, and therefore operates in the very same way as already described.

11.1.9 Scene management

This feature is used in conjunction with KNX devices that support the same function. If the chrono-thermostat function is enabled, 8 independent scene settings are made available for temperature control; each scene has its own code and corresponds to one of the usual operating modes (*Comfort*, *Standby*, *Economy*, *Building protection*). A further option available is *Automatic mode*, which refers to the activation of the hourly scheduler: if the thermostat is in manual mode, and an *Automatic mode* scene is recalled, the hourly programming is activated. If the learning function is enabled, the reception of a “Scene learn” command causes the current operating mode to be stored in association with the transmitted scene code.

11.1.10 Function activation via bus

Three binary (1-bit) communication objects are available to enable or disable following temperature control functions:

- auxiliary heating;
- auxiliary cooling;
- fan control.

Upon reception of a disable telegram from the bus, the control outputs for heating / cooling and auxiliary fan control are automatically lowered or brought to the closed position (0%). The disable condition persists even after the bus recovery following a power failure.

11.2 Device settings

11.2.1 Configuration zone (X)

The *Configuration* tab contains the parameters to perform the basic configuration of the zone X ambient chronothermostat:

- selection of sensors to perform ambient regulation, sensors to display in graphical pages such as relative humidity and air quality, presence detection management;
- selection of the control algorithm: heating only, cooling only or both heating and cooling;
- selection of the daily / weekly scheduler
- selection of seasonal mode switching type: manual, automatic or defined by an external device on the bus;
- scene function enable, with operating mode recall or current mode save.

The Thermostat Zone X \Rightarrow *Configuration* tab is active in ETS application program only if the graphical page Zone Thermostat in Touch&See unit has been enabled: *Pages Configuration* \Rightarrow *Thermostat* = X zones. From now on we will refer (except when qualified) to the parameters of any zone X.

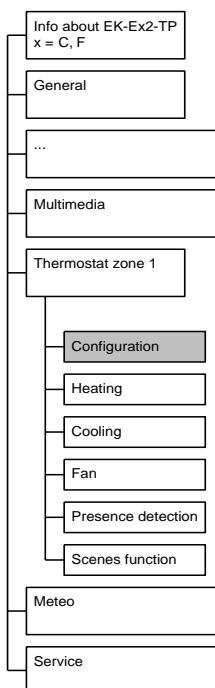

The Touch&See unit in version EK-EF2-TP, if the temperature sensor is enabled in the *Internal sensors* tab, performs the ambient temperature control functions for zone 1 by directly comparing the internal sensor.



For zones from 2 to 8 in version EK-EF2-TP and for all 8 zones in version EK-EC2-TP, the ambient temperature control functions are managed with a least 1 additional temperature sensor whose value is updated by the bus through a communication object.

The ekinex® products family is equipped with an integrated temperature sensor for each pushbutton unit EK-EA2-TP and EK-EB2-TP: the Configuration tab of the Touch&See unit allows to use up to 4 additional sensors and the device performs an arithmetic average between all considered values, allowing to effectively filter local perturbations e.g. from heat sources.

Parameter name	Conditions	Values
Name zone (X)		ASCII text, max. 28 characters
	<p>Please note, while planning the device configuration, that these are static strings, not related with the selected device language. By using Unicode (UTF-8) characters code, the maximum text length can be different from the displayed values. Configured text will be displayed in each zone's page.</p> <p>The name assigned to the zone can be typed or changed in any of the following tabs, if enabled: General ⇒ Name Zone X and Thermostat Zone X ⇒ Configuration ⇒ Name Zone X.</p>	
Sensors timeout (all zones)		hh:mm:ss (00:05:00)
	<p>The device monitors the periodic update of sensor values. If any of the configured values is not updated within the timeout period, the system uses the remaining ones; if no updated values are available, control is interrupted. In all above cases, an alarm is issued.</p> <p>Refer to the description section for details.</p> <p>To deactivate data update monitoring, set the timeout to 0 (00:00:00).</p> <p>This parameter is present only in Thermostat zone 1 ⇒ Configuration; assigned value is common to all configured zones.</p>	
Additional temp. sensor 1		enabled (**)
	<p>(**) In version EK-EF2-TP, for zone 1, the parameter is always enabled if the internal temperature sensor is not enabled (Internal sensors tab ⇒ Use internal temperature sensor = no); otherwise, if the internal temperature sensor is enabled, the parameter takes the default value disabled.</p> <p>In version EK-EF2-TP for zones from 2 to 8 and for all the 8 zones in version EK-EC2-TP, the parameter is always enabled.</p>	
Additional temp. sensor 2		disabled / enabled
	Additional configured sensors are evaluated through an arithmetic average.	
Additional temp. sensor 3		disabled / enabled
	See Additional temp. sensor 2	
Additional temp. sensor 4		disabled / enabled
	See Additional temp. sensor 2	
Weighted temperature cyclic sending interval		no sending / 30 s / 1 min / 2 min / 3 min / 4 min / 5 min / 7 min / 10 min / 15 min / 20 min / 30 min / 45 min / 60 min / 90 min / 120 min
	Timeframe for weighted temperature cyclic sendings (in case more than 1 temperature sensors are used)	
Humidity sensor		disabled / enabled
	Information from this sensor is displayed in the Chrono-thermostat page; the sensor is supposed to measure an indoor humidity value: for the outdoor humidity sensor, please refer to the Meteo page.	
Communication Object dimension	Humidity sensor = enabled	1 byte (DPT 5.001) percentage (0..100%) 2 byte (DPT 9.007) percentage (%)
Air quality sensor		disabled / enabled
	Information from this sensor is displayed in the Chrono-thermostat page.	
Air quality threshold 1	Air quality sensor = enabled	350 [range 0-5000 ppm]
	This threshold is used in the zone page to provide a colored band indication of the air quality in the surrounding area. If the air quality value is less than this threshold, the air quality is considered high (value ≤ 400 [ppm] according to UNI 10339 e EN 13779) and the bands are colored in blue.	

Parameter name	Conditions	Values
Air quality threshold 2	Air quality sensor = enabled	500 [range 0-5000 ppm]
	<i>If air quality value is between Threshold1 and Threshold2, the air quality is considered average (value in range 400÷600 [ppm] according to UNI 10339 e EN 13779) and the bands are colored in green.</i>	
Air quality threshold 3	Air quality sensor = enabled	800 [range 0-5000 ppm]
	<i>If air quality value is between Threshold2 and Threshold3, the air quality is considered poor (value in range 600÷1000 [ppm] according to UNI 10339 e EN 13779) and the bands are colored in yellow.</i>	
Air quality threshold 4	Air quality sensor = enabled	1200 [range 0-5000 ppm]
	<i>If the air quality value is greater than this threshold, the air quality is considered low (value ≥1000 [ppm] according to UNI 10339 e EN 13779) and the bands are colored in red.</i>	
Internal/external chrono function		disabled / enabled
	<i>Enables the chrono program</i>	
HVAC mode cyclic sending interval		no sending / 30 s / 1 min / 2 min / 3 min / 4 min / 5 min / 7 min / 10 min / 15 min / 20 min / 30 min / 45 min / 60 min / 90 min / 120 min
	<i>Timeframe between cyclic sendings</i>	
Presence detection		disabled / enabled
	<i>Enables the presence detection with up to 4 sensors. The logic OR of the sensor states can be used to extend the comfort, to limit the comfort or to extend and limit the comfort. For the detailed configuration of the presence detection function please refer to the Presence detection configuration menu, described below.</i>	
Thermostat function		heating cooling both heating and cooling
Command communication object	Thermostat function = both heating and cooling	unique separated
	<i>Using a unique communication object makes it easier to logically connect the actuator in case of 2 pipes plants.</i>	
Heating - cooling switch over	Thermostat function = both heating and cooling	manual / from bus / automatic
Heating - cooling after download	Heating - cooling switch over = manual	no change / heating / cooling
	<i>Sets the thermostat function after the application download, when manual mode is selected</i>	
Heating - cooling cyclic sending interval	Heating - cooling switch over = manual or automatic	no sending / 30 s / 1 min / 2 min / 3 min / 4 min / 5 min / 7 min / 10 min / 15 min / 20 min / 30 min / 45 min / 60 min / 90 min / 120 min
	<i>If the switching mode is elaborated internally, the value can be updated through a communication object on the bus and sent to other devices.</i>	
Chronothermostat modes	Internal/external chrono function = enabled	comfort-standby comfort-economy
	<i>Automatic daily-weekly scheduling is performed on 2 levels. Programming between comfort and standby modes is suitable for frequent occupation application and / or high inertial systems. Vice-versa, programming between comfort and economy is more suitable to application with occasional occupation and / or heating / cooling systems with low inertia.</i>	

Parameter name	Conditions	Values
Setpoint cyclic sending interval		no sending / 30 s / 1 min / 2 min / 3 min / 4 min / 5 min / 7 min / 10 min / 15 min / 20 min / 30 min / 45 min / 60 min / 90 min / 120 min
	<i>The setpoint that can be cyclically sent is the actual one, forced by the operating mode manually selected by the user or automatically selected by the daily-weekly scheduling. The actual setpoint takes also into account the status of window contacts and presence detector (if corresponding function have been enabled).</i>	
Max manual temperature change		not allowed, $\pm 1^{\circ}\text{C}$, $\pm 2^{\circ}\text{C}$, $\pm 3^{\circ}\text{C}$, $\pm 4^{\circ}\text{C}$, $\pm 5^{\circ}\text{C}$, $\pm 6^{\circ}\text{C}$, $\pm 7^{\circ}\text{C}$, $\pm 8^{\circ}\text{C}$, $\pm 9^{\circ}\text{C}$, $\pm 10^{\circ}\text{C}$
	<i>The parameter defines the maximum interval of variation for manual set modification. Please refer to the user interface chapter for more detailed information about the setting page "set manual".</i>	
Max temp. setpoint change		not allowed, $\pm 1^{\circ}\text{C}$, $\pm 2^{\circ}\text{C}$, $\pm 3^{\circ}\text{C}$, $\pm 4^{\circ}\text{C}$, $\pm 5^{\circ}\text{C}$, $\pm 6^{\circ}\text{C}$, $\pm 7^{\circ}\text{C}$, $\pm 8^{\circ}\text{C}$, $\pm 9^{\circ}\text{C}$, $\pm 10^{\circ}\text{C}$
	<i>The parameter defines the maximum interval of variation for operating modes set modification. Please refer to the user interface chapter for more detailed information about the setting page "set operating mode".</i>	
Transmission delay after mode change (all zones)		hh:mm:ss:fff (00:00:04.000)
	<i>When the operating mode is manually forced by the user or automatically set by daily-weekly scheduling, it can be sent to other thermoregulation devices on the bus acting as slaves. If modified, the operating mode can be sent over the bus after a configurable delay</i>	
Fan		disabled / enabled
	<i>The fan parameter enables the corresponding tab in the ETS application program in order to configure the fancoil fan.</i>	
Scene function		disabled / enabled
	<i>The scene function parameter enables the corresponding tab in the ETS application program.</i>	

Object name	Conditions	Dimens.	Flags	DPT	No. Comm. Obj.
Zone (X) – Temperature sensor 1	Always active	2 Bytes	C-W---	[9.001] temperature ($^{\circ}\text{C}$)	665, 718, 771, 824, 877, 930, 983, 1036
Zone (X) – Temperature sensor 2	Parameter Temperature sensor 2 = enabled	2 Bytes	C-W---	[9.001] temperature ($^{\circ}\text{C}$)	666, 719, 772, 825, 878, 931, 984, 1037
Zone (X) – Temperature sensor 3	Parameter Temperature sensor 3 = enabled	2 Bytes	C-W---	[9.001] temperature ($^{\circ}\text{C}$)	667, 720, 773, 826, 879, 932, 985, 1038
Zone (X) – Temperature sensor 4	Parameter Temperature sensor 4 = enabled	2 Bytes	C-W---	[9.001] temperature ($^{\circ}\text{C}$)	668, 721, 774, 827, 880, 933, 986, 1039
Zone (X) – Humidity sensor	Parameter humidity sensor = enabled	2 Bytes	C-W---	[5.001] percentage (0..100%) [9.007] percentage (%)	670, 723, 776, 829, 882, 935, 988, 1041
Zone (X) – Air quality sensor	Parameter air quality sensor = enabled	2 Bytes	C-W---	[9.008] parts / million (ppm)	671, 724, 777, 830, 883, 936, 989, 1042

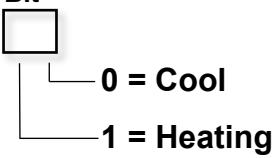
Object name	Conditions	Dimens.	Flags	DPT	No. Comm. Obj.												
Zone (X) – Actual setpoint		2 Bytes	CR-T--	[9.001] temperature (°C)	672, 725, 778, 831, 884, 937, 990, 1043												
Zone (X) – heating / cooling status out	Thermostat function = both heating and cooling; Heating - cooling switch over = manual or automatic	1 Bit	CR-T--	[1.100] heating / cooling	690, 743, 796, 849, 902, 955, 1008, 1061												
<p>The communication object is sent over the bus after an internally elaborated switching event.</p> <p style="text-align: center;">[1.100] DPT Heat / Cool 1 Bit</p> <div style="text-align: center;">  </div>																	
Zone (X) – heating / cooling status in	Thermostat function = both heating and cooling; Heating - cooling switch over = from bus	1 Bit	C-W---	[1.100] heating / cooling	691, 744, 797, 850, 903, 956, 1009, 1062												
<p>The communication object is received from the bus. At the switching event the internal regulators of the primary and auxiliary stage (if enabled) switch the conduction mode. In addition, the pages will also detect the switched conduction mode.</p>																	
Zone (X) – HVAC mode in		1 Bit	C-W---	[20.102] HVAC mode	711, 764, 817, 870, 923, 976, 1029, 1081												
Zone (X) – HVAC forced mode in		1 Bit	C-W---	[20.102] HVAC mode	712, 765, 818, 871, 924, 977, 1030, 1082												
Zone (X) – HVAC mode out	Send HVAC mode = enabled	1 Bit	CR-T--	[20.102] HVAC mode	713, 766, 819, 872, 925, 978, 1031, 1083												
<p>Bits 5, 8 are reserved.</p> <p style="text-align: center;">[20.102] DPT HVAC Mode 1 Byte</p> <div style="text-align: center;"> <table border="0" style="width: 100%;"> <tr> <td style="text-align: center;">AUTO</td> <td style="text-align: center;">COMFORT</td> <td style="text-align: center;">STAND-BY</td> </tr> <tr> <td style="text-align: center;"> <div style="border: 1px solid black; padding: 2px; display: inline-block;">0 0 0 0</div> </td> <td style="text-align: center;"> <div style="border: 1px solid black; padding: 2px; display: inline-block;">0 0 0 1</div> </td> <td style="text-align: center;"> <div style="border: 1px solid black; padding: 2px; display: inline-block;">0 0 1 0</div> </td> </tr> <tr> <td style="text-align: center;">ECONOMY</td> <td style="text-align: center;">PROTECTION</td> <td></td> </tr> <tr> <td style="text-align: center;"> <div style="border: 1px solid black; padding: 2px; display: inline-block;">0 0 1 1</div> </td> <td style="text-align: center;"> <div style="border: 1px solid black; padding: 2px; display: inline-block;">0 1 0 0</div> </td> <td></td> </tr> </table> </div>						AUTO	COMFORT	STAND-BY	<div style="border: 1px solid black; padding: 2px; display: inline-block;">0 0 0 0</div>	<div style="border: 1px solid black; padding: 2px; display: inline-block;">0 0 0 1</div>	<div style="border: 1px solid black; padding: 2px; display: inline-block;">0 0 1 0</div>	ECONOMY	PROTECTION		<div style="border: 1px solid black; padding: 2px; display: inline-block;">0 0 1 1</div>	<div style="border: 1px solid black; padding: 2px; display: inline-block;">0 1 0 0</div>	
AUTO	COMFORT	STAND-BY															
<div style="border: 1px solid black; padding: 2px; display: inline-block;">0 0 0 0</div>	<div style="border: 1px solid black; padding: 2px; display: inline-block;">0 0 0 1</div>	<div style="border: 1px solid black; padding: 2px; display: inline-block;">0 0 1 0</div>															
ECONOMY	PROTECTION																
<div style="border: 1px solid black; padding: 2px; display: inline-block;">0 0 1 1</div>	<div style="border: 1px solid black; padding: 2px; display: inline-block;">0 1 0 0</div>																
Zone (X) – Temperature setpoint change lock		1 Bit	C-W---	[1.003] enable	716, 769, 822, 875, 928, 981, 1034, 1086												
<p>The communication object is received from the bus. When the enabling telegram is received, the user is prevented from changing all setpoints in the zone graphical page. The setpoint change lock is retained in case of power supply failure.</p>																	
Zone (X) – Manual mode lock		1 Bit	C-W---	[1.003] enable	717, 770, 823, 876, 929, 982, 1035, 1087												
<p>The communication object is received from the bus. When the enabling telegram is received, the user is prevented from changing the temperature manual setpoints, both in the time unlimited mode and in time limited mode. The manual mode lock is retained in case of power supply failure.</p>																	

11.2.2 Zone heating

Through the *Heating* menu following operations can be performed:

- set algorithm type and internal control parameters;
- enable an auxiliary heating system and set its control parameters;
- enable building protection mode based on window contacts

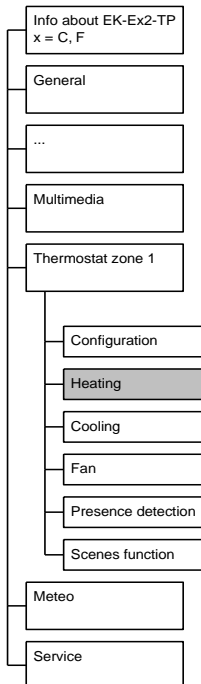

i For a same heating / cooling system, the internal program of the device has two different control loops for heating and for cooling.
If both control loops have to be based on the same parameters, the values of these parameters should be input in both cooling and heating sections of the configuration program.

Conditions: *Configuration* ⇒ Thermostat function = heating or heating and cooling.

Parameter name	Conditions	Values
Comfort temperature setpoint [°C]		21 [range 0-50°C]
Standby temperature setpoint [°C]		18 [range 0-50°C]
	<i>For a correct operation, it is required that Standby temperature setpoint < Comfort temperature setpoint.</i>	
Economy temperature setpoint [°C]		16 [range 0-50°C]
	<i>For a correct operation, it is required that Economy temperature setpoint < Standby temperature setpoint.</i>	
Building protection temp. setpoint [°C]		7 [range 2-10°C]

Parameter name	Conditions	Values
Control type		Continuous PWM (pulse width modulation) 2 points hysteresis
Range	Control type = 2 points hysteresis	0,2 K / 0,3 K / 0,4 K / 0,5 / 0,6 K 0,8 K / 1 K / 1,5 K / 2 K / 2,5 K / 3 K
Control cyclic sending interval	Control type = continuous	hh:mm:ss (00:00:00) (00:00:00 means cyclic sending not enabled)
Control transmission change of value [%]	Control type = continuous	10 [range 0-100%]
PWM cycle time	Control type = PWM (pulse width modulation)	15 min [range 5-240 min]
Heating system	Control type = continuous or PWM	radiant panels (5 K / 240 min), radiators (5 K / 150 min) , electric (4 K / 100 min), fancoils (4 K / 90 min), other
Proportional band [0,1 K]	Control type = continuous or PWM Heating system = other	40 [range 0-255]
	<p><i>The parameter value is expressed in tenths of °C.</i></p> <p><i>This parameter allows to select a customized value for the Proportional band in continuous or PWM control algorithms. Please refer to the corresponding chapter for a detailed description of this parameter; be sure to refer to a technician qualified on HVAC system to determine the most suitable value.</i></p> <p>An incorrect value for this parameter can cause unwanted oscillations of the controlled temperature.</p>	
Integral time [min]	Control type = continuous or PWM Heating system = other	90 [range 0-255 min]
	<p><i>This parameter allows to select a customized value for the Integral time in continuous or PWM control algorithms. Please refer to the corresponding chapter for a detailed description of this parameter; be sure to refer to a technician qualified on HVAC system to determine the most suitable value.</i></p> <p>An incorrect value for this parameter can cause instability of the controlled temperature or excessive delay in reaching the setpoint value.</p>	
Auxiliary heating		disabled / enabled
Disabled from bus	Auxiliary heating = enabled	no / yes
	<i>Enables activation and deactivation of the heating function through a bus telegram.</i>	
Setpoint offset	Auxiliary heating = enabled	1 K / 1,5 K / 2 K / 2,5 K / 3 K / 3,5 K / 4 K / 4,5 K / 5 K / 5,5 K / 6 K

Parameter name	Conditions	Values
Command communication object	Auxiliary heating = enabled	unique separated
	<i>In case Configuration ⇒ Thermostat function = heating, using object separated is suggested; only in case Configuration ⇒ Thermostat function = heating and cooling and when integration is performed by the same actuation device, the object unique is suggested.</i>	
Use window sensors to activate building protection mode	General ⇒ window contacts = enabled	no / yes
	<i>The number of active sensors (up to 4) and their polarity can be configured in the Window Contact Zone X menu.</i>	
Wait time before activating	General ⇒ Window contacts = enabled, Use window sensors to activate building protection mode = yes	hh:mm:ss (00:05:00)
	<i>The delay is only applied to the transition between closed and open window.</i>	

Object name	Conditions	Dimens.	Flags	DPT	No. Comm. Obj.
Zone (X) – Setpoint comfort heating		2 Bytes	CRWTU-	[9.001] temperature (°C)	676, 729, 782, 835, 888, 941, 994, 1047
Zone (X) – Setpoint standby heating		2 Bytes	CRWTU-	[9.001] temperature (°C)	678, 731, 784, 837, 890, 943, 996, 1049
Zone (X) – Setpoint economy heating		2 Bytes	CRWTU-	[9.001] temperature (°C)	680, 733, 786, 839, 892, 945, 998, 1051
Zone (X) – Setpoint building protection heating		2 Bytes	CRWTU-	[9.001] temperature (°C)	682, 735, 788, 841, 894, 947, 1000, 1053
Zone (X) – Heating out command	Control type = 2 points hysteresis or PWM (pulse width modulation); <i>Configuration</i> ⇒ Command communication object = separated	1 Bit	CR-T--	[1.001] switch	684, 737, 790, 843, 896, 949, 1002, 1055
	<i>If the operating mode is set to "both heating and cooling" but the HVAC system only has one actuator (e.g. a 2-pipe system fan-coil with a 1-way valve switching a single heat exchanger), both this communication object and the corresponding one for cooling have to be connected to the same group address (the one also used by the actuator).</i>				
Zone (X) – Heating out command	Control type = continuous; <i>Configuration</i> ⇒ Command communication object = separated	1 Byte	CR-T--	[5.001] percentage (0..100%)	684, 737, 790, 843, 896, 949, 1002, 1055
	<i>See above</i>				

Object name	Conditions	Dimens.	Flags	DPT	No. Comm. Obj.
Zone (X) – Heating and cooling out command	Control type = 2 points hysteresis or PWM (pulse width modulation); <i>Configuration</i> ⇒ Command communication object = unique	1 Bit	CR-T--	[1.001] switch	684, 737, 790, 843, 896, 949, 1002, 1055
<i>In case of 2-pipe systems with operating mode set to "both heating and cooling", the communication object set to unique facilitates the logic connection with the actuator.</i>					
Zone (X) – Heating and cooling out command	Control type = continuous; <i>Configuration</i> ⇒ Command communication object = unique	1 Byte	CR-T--	[5.001] percentage (0..100%)	684, 737, 790, 843, 896, 949, 1002, 1055
<i>See sopra</i>					
Zone (X) – Auxiliary heating output command	Auxiliary heating = enabled; Command communication object = separated	1 Bit	CR-T--	[1.001] switch	685, 738, 791, 844, 897, 950, 1003, 1056
Zone (X) – Auxiliary heating and cooling output command	Auxiliary heating = enabled; Command communication object = unique	1 Bit	CR-T--	[1.001] switch	685, 738, 791, 844, 897, 950, 1003, 1056
Zone (X) – Auxiliary heating disable	Auxiliary heating = enabled; Disabled from bus = yes	1 Bit	C-W---	[1.003] enable	688, 741, 794, 847, 900, 953, 1006, 1059

11.2.2 Zone cooling

Through the *Cooling* menu following operations can be performed:

- set algorithm type and internal control parameters;
- enable an auxiliary heating system and set its control parameters;
- enable building protection mode based on window contacts

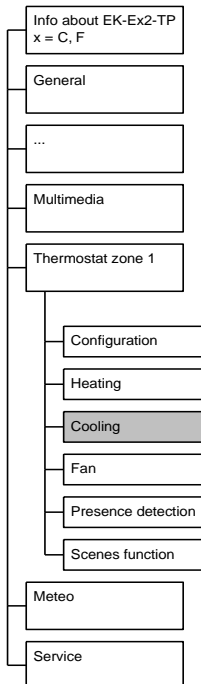

For a same heating / cooling system, the internal program of the device has two different control loops for heating and for cooling.
If both control loops have to be based on the same parameters, the values of these parameters should be input in both cooling and heating sections of the configuration program.

Conditions: *Configuration* ⇒ Thermostat function = cooling or heating and cooling.

Parameter name	Conditions	Values
Comfort temperature setpoint [°C]		23 [range 0-50°C]
Standby temperature setpoint [°C]		26 [range 0-50°C]
	<i>For a correct operation, it is required that Standby temperature setpoint > Comfort temperature setpoint.</i>	
Economy temperature setpoint [°C]		28 [range 0-50°C]
	<i>For a correct operation, it is required that Economy temperature setpoint > Standby temperature setpoint.</i>	
Building protection temp. setpoint [°C]		36 [range 30-50°C]

Parameter name	Conditions	Values
Control type		Continuous PWM (pulse width modulation) 2 points hysteresis
	<i>If Configuration -> Command communication object = separated, all control types are available in the selection box. Otherwise, if Command communication object = unique, only one compatible control type is available in the selection box. It is still possible to select a PWM control type with different parametrization between heating and cooling.</i>	
Range	Control type = 2 points hysteresis	0,2 K / 0,3 K / 0,4 K / 0,5 / 0,6 K 0,8 K / 1 K / 1,5 K / 2 K / 2,5 K / 3 K
Control cyclic sending interval	Control type = continuous	hh:mm:ss (00:00:00) (00:00:00 means cyclic sending not enabled)
Control transmission change of value [%]	Control type = continuous	10 [range 0-100%]
PWM cycle time	Control type = PWM (pulse width modulation)	15 min [range 5-240 min]
Cooling system	Control type = continuous or PWM	radiant panels (5 K / 240 min), fancoils (4 K / 90 min) , other
Proportional band [0,1 K]	Control type = continuous or PWM Cooling system = other	40 [range 0-255]
	<i>The parameter value is expressed in tenths of °C. This parameter allows to select a customized value for the Proportional band in continuous or PWM control algorithms. Please refer to the corresponding chapter for a detailed description of this parameter; be sure to refer to a technician qualified on HVAC system to determine the most suitable value. An incorrect value for this parameter can cause unwanted oscillations of the controlled temperature.</i>	
Integral time [min]	Control type = continuous or PWM Cooling system = other	90 [range 0-255 min]
	<i>This parameter allows to select a customized value for the Integral time in continuous or PWM control algorithms. Please refer to the corresponding chapter for a detailed description of this parameter; be sure to refer to a technician qualified on HVAC system to determine the most suitable value. An incorrect value for this parameter can cause instability of the controlled temperature or excessive delay in reaching the setpoint value.</i>	
Auxiliary cooling		disabled / enabled
Disabled from bus	Auxiliary cooling = enabled	no / si
	<i>Enables activation and deactivation of the heating function through a bus telegram.</i>	
Offset setpoint	Auxiliary cooling = enabled	1 K / 1,5 K / 2 K / 2,5 K / 3 K / 3,5 K / 4 K / 4,5 K / 5 K / 5,5 K / 6 K
Use window sensors to activate building protection mode	General ⇒ window contacts = enabled	no / si
	<i>The number of active sensors (up to 4) and their polarity can be configured in the Window Contact Zone X menu.</i>	

Parameter name	Conditions	Values
Wait time before activating	General ⇒ window contacts = enabled, Use window sensors to activate building protection mode = yes	hh:mm:ss 00:05:00
<i>The delay is only applied to the transition between closed and open window.</i>		

Object name	Conditions	Dimens.	Flags	DPT	No. Comm. Obj.
Zone (X) – Setpoint comfort cooling		2 Bytes	CRWTU-	[9.001] temperature (°C)	677, 730, 783, 836, 889, 942, 995, 1048
Zone (X) – Setpoint standby cooling		2 Bytes	CRWTU-	[9.001] temperature (°C)	679, 732, 785, 838, 891, 944, 997, 1050
Zone (X) – Setpoint economy cooling		2 Bytes	CRWTU-	[9.001] temperature (°C)	681, 734, 787, 840, 893, 946, 999, 1052
Zone (X) – Setpoint building protection cooling		2 Bytes	CRWTU-	[9.001] temperature (°C)	683, 736, 789, 842, 895, 948, 1001, 1054
Zone (X) – Cooling output command	Control type = 2 points hysteresis or PWM (pulse width modulation); <i>Configuration</i> ⇒ Command communication object = separated	1 Bit	CR-T--	[1.001] switch	686, 739, 792, 845, 898, 951, 1004, 1057
Zone (X) – Cooling output command	Control type = continuous; <i>Configuration</i> ⇒ Command communication object = separated	1 Byte	CR-T--	[5.001] percentage (0..100%)	686, 739, 792, 845, 898, 951, 1004, 1057
<i>If the operating mode is set to "both heating and cooling" but the HVAC system only has one actuator (e.g. a 2-pipe system fan-coil with a 1-way valve switching a single heat exchanger), both this communication object and the corresponding one for heating have to be connected to the same group address (the one also used by the actuator).</i>					
Zone (X) – Auxiliary cooling output command	Auxiliary cooling = enabled; Command communication object = separated	1 Bit	CR-T--	[1.001] switch	687, 740, 793, 846, 899, 952, 1005, 1058
<i>See above</i>					
Zone (X) – Auxiliary cooling disable	Auxiliary cooling = enabled; Disabled from bus = yes	1 Bit	C-W---	[1.003] enable	689, 742, 795, 848, 901, 954, 1007, 1060

11.2.3 Zone fan

The control type for the fan e.g. in a fan-coil unit can be enabled and parametrized in the *Fan* menu.

If the flow of the heat exchanger battery is not controlled, the configuration of the setpoint values for the different operating modes is enough to set up the control system; if the flow of the heat exchanger battery is intercepted, either by a one- or two-way valve (2- or 4-pipe systems), the *Control type* parameters in the *Heating* and *Cooling* menus should also be correctly set.

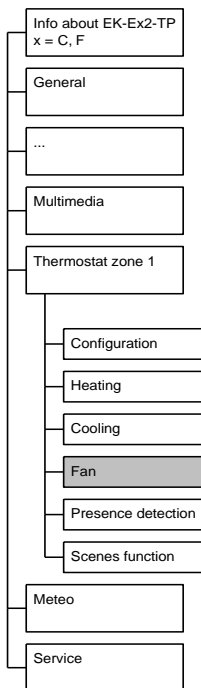

Conditions: *Configuration* ⇒ Fan = enabled.

Parameter name	Conditions	Values
Fan function		heating cooling both heating and cooling
Control type		1 speed 2 speeds 3 speeds continuous regulation
Threshold first speed [0,1 K]		10 (range 0-255)
	<i>The parameter value is expressed in tenths of °C. If Fan function = both heating and cooling, the threshold value applies to both modes.</i>	
Threshold second speed [0,1 K]	Control type = 2 speeds	20 (range 0-255)
	<i>The parameter value is expressed in tenths of °C. If Fan function = both heating and cooling, the threshold value applies to both modes. For a correct operation, it is required that Threshold 2nd speed > Threshold 1st speed.</i>	

Parameter name	Conditions	Values			
Threshold third speed [0,1 K]	Control type = 3 speeds	30 (range 0-255)			
	<i>The parameter value is expressed in tenths of °C. If Fan function = both heating and cooling, the threshold value applies to both modes. For a correct operation, it is required that Threshold 3rd speed > Threshold 2nd speed.</i>				
Proportional band [0,1 K]	Control type = continuous regulation	30 (range 0-255)			
	<i>The parameter value is expressed in tenths of °C. If Fan function = both heating and cooling, the parameter value applies to both modes.</i>				
Minimum change of value to send [%]	Control type = continuous regulation	10 (range 2-40)			
	<i>Please refer to Control Algorithms chapter.</i>				
Use flow probe to start fan	Fan function = heating or both heating and cooling	no / yes			
Min. water temp. to start fan [°C]	Use flow probe to start fan = yes	35 (range 0-255)			
	<i>If Fan function = both heating and cooling, fan start in cooling mode is not related to min. water temp. value. Only heating mode is related to min. water temp. value. The device monitors the periodic update of sensor values when the timeout parameter set in "General" tab expires. If no updated values are available, control is interrupted. In this case, an alarm is issued.</i>				
Fan controller disable from bus		no / yes			
Disable signal	Fan controller disable from bus = yes	not inverted / inverted			
Fan on delay		0 s, 10 s, 20 s, 30 s, 1 min, 1,5 min, 2 min, 2,5 min, 3 min, 4 min, 5 min, 6 min, 8 min, 10 min, 12 min			
Fan off delay		0 s, 10 s, 20 s, 30 s, 1 min, 1,5 min, 2 min, 2,5 min, 3 min, 4 min, 5 min, 6 min, 8 min, 10 min, 12 min			
Object name	Conditions	Dimens.	Flags	DPT	No. Comm. Obj.
Zone (X) – Fans speed continuous	Control type = continuous regulation	1 Byte	CR-T-	[5.001] percentage (0..100%)	694, 747, 800, 853, 906, 959, 1012, 1064
Zone (X) – Fans speed 1	Control type >= 1 speed	1 Bit	CR-T-	[1.001] switch	694, 747, 800, 853, 906, 959, 1012, 1064
Zone (X) – Fans speed 2	Control type >=2 speeds	1 Bit	CR-T-	[1.001] switch	695, 748, 801, 854, 907, 960, 1013, 1065
Zone (X) – Fans speed 3	Control type = 3 speeds	1 Bit	CR-T-	[1.001] switch	696, 749, 802, 855, 908, 961, 1014, 1066
Zone (X) – Coil temperature	Use flow probe to start fan = yes	2 Bytes	C-W--	[9.001] temperature (°C)	701, 754, 807, 860, 913, 966, 1019, 1071

Parameter name	Conditions			Values
Zone (X) – Fans controller disable	Fans controller disable from bus = yes	1 Bit	C-W--	[1.002] boolean 700, 753, 806, 859, 912, 965, 1018, 1070

11.2.4 Zone presence detection

In this tab the energy spare features based on presence detection can be configured. Up to 4 presence detection sensors can be configured, acting in logical OR mode: for each sensor the contact state corresponding to the occupancy state is selected. Please refer to the *Occupation status management* chapter to choose the most suitable strategy for your application.

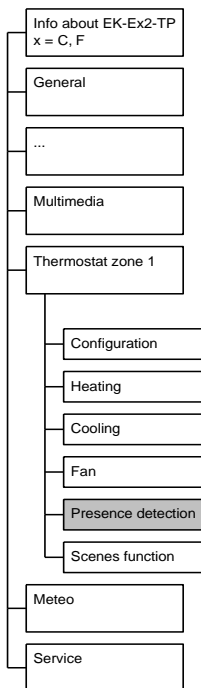

Conditions: *Configuration* ⇒ Presence detection = enabled.

Parameter name	Conditions	Values
Presence sensors use		comfort extension comfort limitation comfort extension and comfort limitation
	<i>See Occupation status management chapter.</i>	
Max absence time before switching HVAC mode		hh:mm:ss (00:15:00)
	<i>The switching delay only affects the transition from occupancy to non-occupancy state.</i>	

Parameter name	Conditions	Values
Switch between modes	Presence sensors use = comfort limitation or comfort extension and comfort limitation	comfort-standby comfort-economy
	<i>The switching delay only affects the transition from occupancy to non-occupancy state. The selection made with this parameter is independent from the mode pairs selected for the chronothermostat function (Thermostat / Configuration / Chronothermostat modes).</i>	
Number of sensors		1 (from 1 to 4)
	<i>The occupancy state is determined by the logical OR combination of all enabled sensors: if at least 1 sensor is active then presence is detected.</i>	
Sensor (Y)		NC (normally closed) NO (normally open)
	<i>NC (normally closed): the sensor signal value is "On" when presence is detected, "Off" otherwise; vice-versa for NO.</i>	

Object name	Conditions	Dimens.	Flags	DPT	No. Comm. Obj.
Zone (X) – Presence sensor Y		1 Bit	C-W---	[1.018] occupancy	(X=1) 707, 708, 709, 710 (X=2) 760, 761, 762, 763 (X=3) 813, 814, 815, 816 (X=4) 866, 867, 868, 869 (X=5) 919, 920, 921, 922 (X=6) 972, 973, 974, 975 (X=7) 1025, 1026, 1027, 2018 (X=8) 1077, 1078, 1079, 1080

11.2.5 Zone scenes function

This tab allows to configure up to 8 scenes, each one with an identification number and an operating mode to recall (by pressing a pushbutton or by a KNX device supporting this feature). In case of Learning Mode enabled, receiving a scene memorization telegram associates the scene to the currently set operating mode.

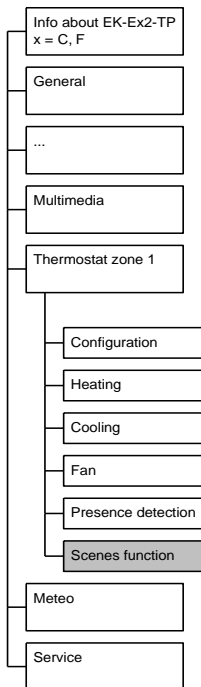

Conditions: *Configuration* ⇒ Scene function = enabled.

i

Please pay attention to the value of the “Download overwrites” parameter.
 Downloading a new or modified configuration from ETS, particularly on a system which is already installed and in operation, can lead to the loss of the stored scene settings.

Parameter name	Conditions	Values
Download overwrites		disabled / enabled
	<i>If the value is “enabled”, the operating modes are replaced with those configured under “HVAC mode”; otherwise they are left unchanged.</i>	
Scene X		disabled / enabled
Scene number	Scene X = enabled	1 (range 1-64)
HVAC mode	Scene X = enabled	auto / comfort / standby / economy / building protection
Activation delay	Scene X = enabled	hh:mm:ss:ff (00:00:00:00)
	<i>When a scene setting telegram is received, the actual mode switch is performed after the specified delay.</i>	
Learning mode	Scene X = enabled	disabled / enabled

Object name	Conditions	Dimens.	Flags	DPT	No. Comm. Obj.								
Zone (X) – HVAC scene number		1 Byte	C-W---	[17.001] scene number [18.001] scene control	706, 759, 812, 865, 918, 971, 1024, 1076								
<p><i>Saves or recalls a scene.</i> <i>The lowest 6 bits in the byte form the code of the scene, while the highest bit is the operation code (save or recall).</i></p> <div style="text-align: center;"> <p>1 Byte</p> <p>Bit number</p> <table border="1" style="margin: auto;"> <tr> <td style="padding: 5px;">7</td> <td style="padding: 5px;">6</td> <td style="padding: 5px;">5</td> <td style="padding: 5px;">4</td> <td style="padding: 5px;">3</td> <td style="padding: 5px;">2</td> <td style="padding: 5px;">1</td> <td style="padding: 5px;">0</td> </tr> </table> <div style="margin-top: 10px;"> <div style="border: 1px solid black; width: 150px; height: 20px; margin: 0 auto; text-align: center; padding: 2px;">scene number (1-64)</div> <div style="margin: 5px 0 0 40px;">not used</div> <div style="margin: 5px 0 0 0px;">0 = recall , 1 = save</div> </div> </div>						7	6	5	4	3	2	1	0
7	6	5	4	3	2	1	0						

12. Meteo page

12.1 Online operations

The Meteo page allows to display from a unique position (the Touch&See) all data sent from a KNX meteo station and / or from single KNX sensors. In the following picture graphical data are shown.

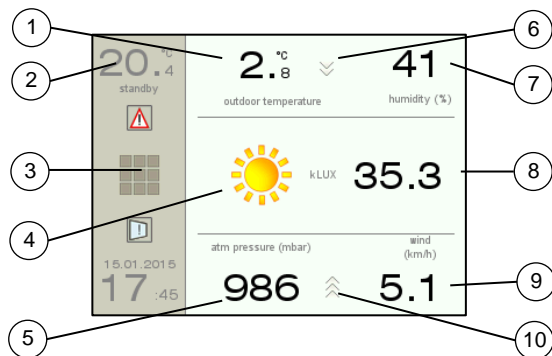

- 1) Outside temperature, selecting field takes to the daily max / min page.
- 2) Ambient temperature
- 3) Shortcut to Home screen
- 4) Indicator of current general meteo condition
- 5) Atmospheric pressure esterna [bar]
- 6) Trend for outside temperature (arrow pointing up or down)
- 7) Outside relative humidity [%]
- 8) External brightness [lux]
- 9) Wind speed [km / h] or [m / s]
- 10) Trend for atmospheric pressure (arrow pointing up or down)

The graphic indicator icon for general meteo condition combines the information from the outdoor light, rain and temperature sensor. If data are not available from the KNX meteo station or not configured in the ETS application program, they will be displayed as dashes.

12.2 Device settings

The *Settings* tab allows to select quantities obtained by a KNX meteo station to display in the meteo page.

The tab is active in ETS application program only if the meteo page has been enabled in the Touch&See: *Pages configuration* ⇒ *Meteo* = enabled.

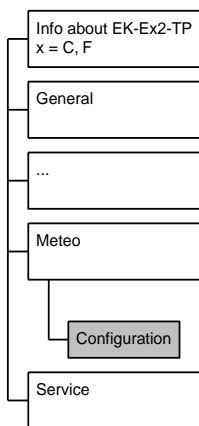

If selected quantities are not available on the meteo station, they may activate timeout and / or fault alarms. It is recommended to select only the quantities that are actually available on the bus.

Parameter name	Conditions	Values
Temperature		yes / no
	<i>This parameter enables the visualization of the outside temperature value.</i>	
Rain		yes / no
	<i>This parameter enables the visualization of rain present or absent.</i>	
Wind		yes / no
	<i>This parameter enables the visualization of the wind speed value.</i>	
Communication Object dimension	Wind = yes	Beaufort force scale (DPT 20.014) m / s (DPT 9.005) km / h (DPT 9.028)
	<i>It is possible to choose a specific datapoint type for the communication object. The unit displayed in the page is congruent with the datapoint type selected.</i>	
Humidity		yes / no
	<i>This parameter enables the visualization of the relative humidity value.</i>	
Communication Object dimension	Humidity = yes	1 byte (DPT 5.001) 2 bytes (DPT 9.007)
	<i>It is possible to choose a specific datapoint type for the communication object.</i>	
Atmospheric pressure		yes / no
	<i>This parameter enables the visualization of the atmospheric pressure value [mbar].</i>	
Brightness		yes / no
	<i>This parameter enables the visualization of the eternal brightness value [lux]. The brightness value is represented by an analog variable.</i>	
Twilight		yes / no
	<i>This parameter enables the visualization of natural outside light status through a twilight sensor. The value is represented by a binary variable.</i>	
Sensors timeout		hh:mm:ss (00:05:00)
	<i>The device monitors the periodic update of sensor values. If any of the configured values is not updated within the timeout period, the system uses the remaining ones; if no updated values are available, control is interrupted. In all above cases, an alarm is issued. Refer to the description section for details. To deactivate data update monitoring, set the timeout to 0 (00:00:00).</i>	

Object name	Conditions	Dimens.	Flags	DPT	No. Comm. Obj.
Outside temperature	Parameter Temperature = yes	2 byte	C-W---	[9.001] temperature (°C)	589
Rain	Parameter Rain = yes	1 bit	C-W---	[1.002] boolean	590
Wind speed	Parameter Wind = yes	1 byte 2 byte	C-W---	[20.014] wind force scale (0..12) [9.005] speed (m / s) [9.028] wind speed (km / h)	591
External humidity	Parameter Humidity = yes	1 byte 2 byte	C-W---	[5.001] percentage (0..100%) [9.007] percentage (%)	592
Atmospheric pressure	Parameter Atmospheric pressure = yes	2 byte	C-W---	[9.006] pressure (Pa)	593

<i>Object name</i>	<i>Conditions</i>	<i>Dimens.</i>	<i>Flags</i>	<i>DPT</i>	<i>No. Comm. Obj.</i>
External brightness	Parameter Brightness = yes	2 byte	C-W---	[9.004] lux (Lux)	594
Twilight	Parameter Twilight = yes	1 bit	C-W---	[1.002] boolean	595

13. Multimedia page

13.1 Online operations

The Multimedia page allows the Touch&See to interact with a KNX multimedia station. The page has the following command elements:

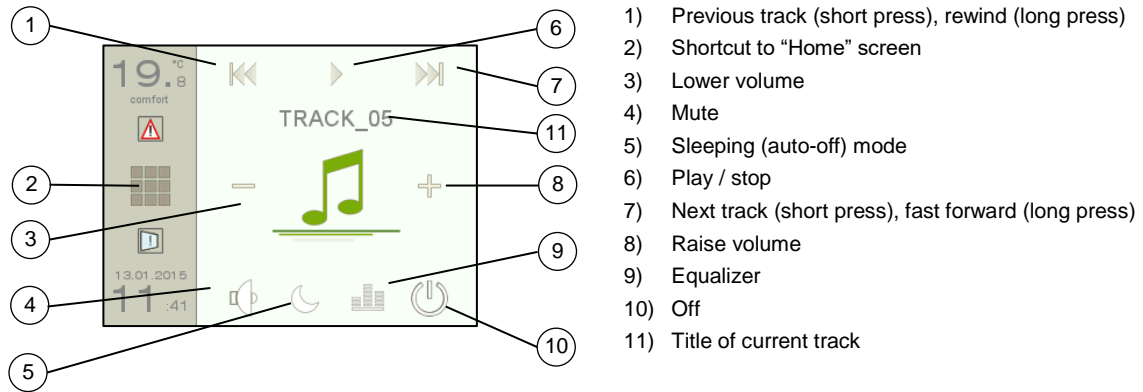

Each command of the page is connected to one or more communication objects that can be synchronized with the multimedia station commands.

The *Sleeping* and *Equalizer* icons take to the respective settings pages, which are enabled according to the configuration in the ETS application program.

Sleeping mode

- Manual activation / deactivation of auto-off mode
- Off time setting

Equalizer

It is possible to amplify or attenuate the signal inside a selected frequency band and modify the volume balance.

- Treble
- Bass
- Balance

13.2 Device settings

The tab is active in ETS application program only if the meteo page has been enabled in the Touch&See: *Pages configuration* ⇒ Multimedia = enabled.

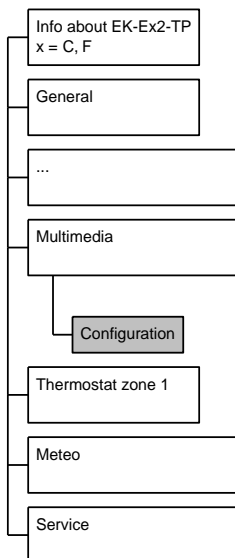

Parameter name	Conditions	Values
Sleeping mode		enabled / disabled
	<i>Enables in MULTIMEDIA page the control of sleeping mode with a sound system automatic shutdown after a customizable inactivity time.</i>	
Equalizer		enabled / disabled
	<i>Enables in MULTIMEDIA page the functions for bass, treble and balance control.</i>	

Object name	Conditions	Dimens.	Flags	DPT	No. Comm. Obj.
Multimedia main power		1 Bit	CR-T--	[1.001] switch	653
Multimedia skip		1 Bit	CR-T--	[1.007] step	654
Multimedia fast forward-backward		4 Bit	CR-T--	[3.007] dimming control	655

After a pression of the fast-forward and rewind pushbuttons, 4-bit telegrams are sent (also used to command the dimming actuators).
Three values are used which mean start move forward 100%, start rewind 0% or stop the change.

[3.007] Dimming 4 bit

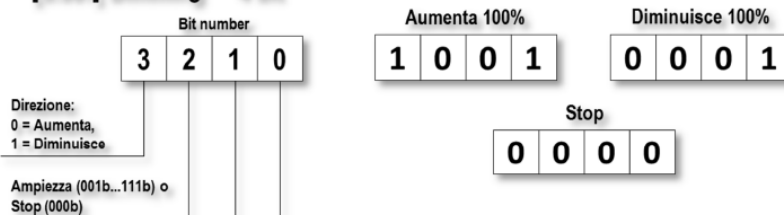

Fast forward / rewind values are sent when a long press action occurs and stop value on press release.

Object name	Conditions	Dimens.	Flags	DPT	No. Comm. Obj.
Multimedia play / stop		1 Bit	CR-T--	[1.010] play / stop	656
Multimedia volume step		1 Bit	CR-T--	[1.007] step	657
Multimedia mute		1 Bit	CR-T--	[1.003] enable	658
Multimedia text		N Byte	C-W---	[16.000] char string (ASCII) [16.001] char string (ISO 8859-1)	659
Multimedia sleep enable	Parameter Sleeping mode = enabled	1 Bit	CR-T--	[1.003] enable	660
Multimedia sleeptime	Parameter Sleeping mode = enabled	1 Byte	CR-T--	[7.006] time (min)	661
Multimedia bass step	Parameter Equalizer = enabled	1 Bit	CR-T--	[1.007] step	662
Multimedia treble step	Parameter Equalizer = enabled	1 Bit	CR-T--	[1.007] step	663
Multimedia balance step	Parameter Equalizer = enabled	1 Bit	CR-T--	[1.007] step	664

14. Service functions

14.1 Online operations

14.1.1 Timers

The Timers feature allows to transmit a telegram of a configurable type and value at scheduled moments of the day. Timers can be programmed by the end user of the device; a configurable number of up to 10 timers can be made available to the user. A name (up to 28 characters long) can be assigned to each timer. The parametrization of a timer requires that a *Profile* is assigned to each day of the week. Each timer has seven scheduling profiles available (named P1 to P7), so that each day of the week can have a different profile.

Each profile includes up to 3 recurrences of the timer event; each recurrence has a different, configurable, time of day for activation.

Each timer can be configured to be possibly enabled or disabled through a bus telegram.

<p>The <i>Timer list</i> page displays the list of the timers configured in ETS, each one with an identification name. A short press selects the timer to be changed; a short press on (+) or (-) activates / deactivates the selected timer.</p> <p>A long press on an entry takes to the parametrization page for the profile of the respective timer.</p>	<p>In this page, the user associates daily activation times and days of the week. A short press selects the day of the week; a short press on (+) or (-) changes the program number assigned to the selected day (P1..P7).</p> <p>A long press on the field that shows the currently selected profile takes to the <i>Program scheduling</i> subpage.</p>	<p>The event associated to each program can be triggered at up to 3 times of the day.</p> <p>The time for each activation can be set by selecting the respective field and acting on the (+) and (-) buttons; the time is changed in 15-minute intervals.</p> <p>By pressing (OK) the change is confirmed, by pressing the "Delete" button on a selected field, the corresponding time is deactivated.</p>

Timer events can be used to perform simple scheduled functions which have daily periodicity, like e.g. a garden sprinkler system; the telegram transmitted by the timer would then activate a corresponding operation on the actuator. For operations which require events of different type, such as an additional explicit "Off" command after a certain duration, two different timers – one for activation, the other for deactivation – could be assigned to the same task.

14.1.2 Presence simulation

Presence simulation is a feature that automatically carries out ordinary daily operations like switching lights or raising and lowering blinds, according to a pre-recorded sequence, when the building is not occupied. Up to 16 Communication Objects (DPT 1.001 switch) can be defined and associated to the actuator functions that have to take part in the sequence. The communication objects (*Presence simulation X*) must be associated through group addresses to the corresponding actuator command objects planned to realize the presence simulation. When the Presence simulation is activated, the system starts reproducing the changes of state for

the involved objects in real time, starting from one week before the activation moment. If the activation lasts for a longer time, the sequence is reiterated.

The simulation can be activated either by the end user, through the command on the corresponding page, or through a Communication Object.

14.1.3 Alarms

Touch&See performs alarm functions in terms of visualization, acknowledge and cancellation. Two categories of alarms are defined:

- Externally generated alarms. A maximum of 20 alarms can be defined, each of them with a corresponding dedicated Communication Object (DPT 1.005 alarm). The associated text and alarm trigger condition can be configured in the ETS application program;
- Internally generated alarms. This category groups all internal or external sensor malfunction; external sensors, when enabled, are considered as malfunctioning either when a “failure” telegram is received or when no information is received within a configurable timeout. Timeout durations are configurable in the ETS application program.

i

Timeouts are configurable parameters in ETS application program. Please verify that all following parameters are correctly set in order to activate the corresponding alarm functions:

- Date and time ⇒ Date and time timeout (Date and time synchronization = from bus)
- Thermostat ⇒ Configuration ⇒ Sensors timeout
- Meteo ⇒ Configuration ⇒ Sensors timeout

The timeout alarms on failed update can be disabled by setting the value 0 (00:00:00) for the timeout duration.

The screen page for the alarm list is always enabled, in order to allow the display of internally generated alarms; enabling the alarm page in the page configuration section actually allows Externally generated alarms to be also displayed in the same page.

The main features of the user interface are here summarized.

Alarm list page: a short press downwards or upwards scrolls the alarm list; a short press on an alarm entry takes to the *Alarm details* page.







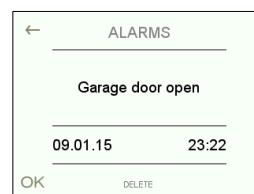
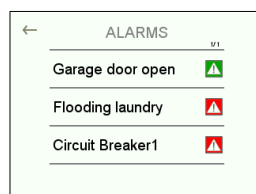

Alarm details page: a short press on (+) or (-) displays the next / previous alarm in the alarm list (without going back to previous page); a short press on the “Delete” button removes the alarm from the list (provided it is no longer active); a short press on the “OK” button marks the alarm as acknowledged by the user; the back arrow “←” returns to the alarm list page.

The Alarm list page shows the list of the latest 40 issued alarms.

Each alarm in the list is displayed with a short descriptive test and with an icon summarizing the source of the alarm (external or internally generated for timeout or sensor failure), the activity state (still active or ceased) and the acknowledgement by the user.



ALARM ICONS

-  Externally generated alarm, active and not acknowledged
-  Externally generated alarm, ceased and not acknowledged
-  Externally generated alarm, active and acknowledged
-  Externally generated alarm, ceased and acknowledged
-  Internally generated alarm, active and not acknowledged
-  Internally generated alarm, ceased and not acknowledged
-  Internally generated alarm, active and acknowledged
-  Internally generated alarm, ceased and acknowledged

14.2 Device settings

14.2.1 Timers

The *Service / Timers* menu allows to set the parameters for each of the 10 definable events, which can be assigned to the program scheduler.

These parameters include:

- a descriptive text to be displayed in the timer page
- type, size and value of the communication object to be sent as a programmed event;
- the option of enabling or disabling the event through a bus telegram.

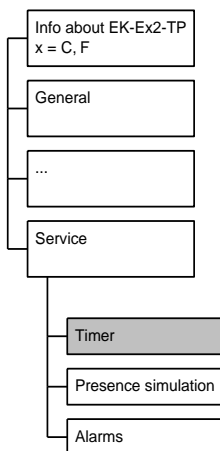

The *Service* ⇒ *Timer* tab is active in the ETS application program if the Timer page has been enabled: *Pages configuration* ⇒ *Timer* = enabled.

Parameter name	Conditions	Values
Timer (X)		enabled / disabled
Text	Timer (X) = enabled	ASCII text, max. 28 characters
	<i>The maximum length of each text string is 28 characters in standard ASCII code. If the Unicode (UTF-8) character encoding is used, the available string size might be smaller. The strings are static, i.e. they do not change according to the general language setting of the device.</i>	
Object dimension	Timer (X) = enabled	1 bit value, 2 bit value, 1 byte unsigned value, Valore a 1 byte percentage, 1 byte signed value, 2 bytes unsigned value, 2 bytes signed value, 2 bytes floating value, Scene

Parameter name	Conditions	Values
Value to send	Timer (X) = enabled Value based on parameter object dimension	1 bit value (on / off), 2 bit value (disable / enable off-up / enable on-down) 1 byte unsigned value (0..255), Valore a 1 byte percentage (0..100), 1 byte signed value (-128..127), 2 bytes unsigned value (0..65535), 2 bytes signed value (-32768..32767), 2 bytes floating value (-671088,64..670760,96), Scene (1..64)
Enabled from bus	Timer (X) = enabled	yes / no
<i>The parameters allows to activate / deactivate the timer through a telegram coming from a supervisor on the bus.</i>		
Behavior on bus on	Enabled from bus = yes	disabled, enabled, as previous
<i>By selecting the option "as previous", when bus voltage is restored (i.e. at power-up) the timer will retain the same activation / deactivation status it had at power off. If the option is not selected, the device will always restart either disabled or enabled.</i>		

Object name	Conditions	Dimens.	Flags	DPT	No. Comm. Obj.
Timer X – command 1-bit		1 Bit	R-CT--	[1.001] switch	633, 634, 635, 636, 637, 638, 639, 640, 641, 642
Timer X – command 2-bits		2 Bit	R-CT--	[2.008] direction control 1	633, 634, 635, 636, 637, 638, 639, 640, 641, 642
Timer X – command 1-unsigned byte		1 Byte	R-CT--	[5.010] counter pulses (0..255)	633, 634, 635, 636, 637, 638, 639, 640, 641, 642
Timer X – command percentage		1 Byte	R-CT--	[5.001] percentage (0..100%)	633, 634, 635, 636, 637, 638, 639, 640, 641, 642
Timer X – command 1-signed byte		1 Byte	R-CT--	[6.001] percentage (-128..127%), [6.010] counter pulses (-128..127)	633, 634, 635, 636, 637, 638, 639, 640, 641, 642
Timer X – command 2-unsigned bytes		2 Byte	R-CT--	[7.001] pulses	633, 634, 635, 636, 637, 638, 639, 640, 641, 642
Timer X – command 2-signed bytes		2 Byte	R-CT--	[8.001] pulses difference	633, 634, 635, 636, 637, 638, 639, 640, 641, 642
Timer X – command a 2 Byte flottante		2 Byte	R-CT--	[9.0xx]	633, 634, 635, 636, 637, 638, 639, 640, 641, 642
Timer X – command scene number		1 Byte	R-CT--	[17.001] scene number	633, 634, 635, 636, 637, 638, 639, 640, 641, 642
Timer X – enable		1 Bit	-WC---	[1.003] enable	643, 644, 645, 646, 647, 648, 649, 650, 651, 652

14.2.2 Presence simulation

The *Service* ⇒ *Presence simulation* tab is active in ETS application program if the Presence Simulation page has been enabled in the Touch&See: *Pages configuration* ⇒ Presence simulation = enabled.

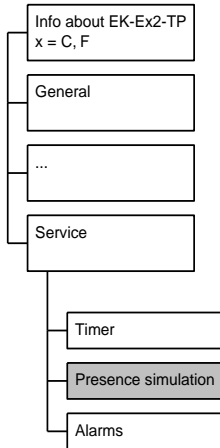

Parameter name	Conditions	Values
Presence simulation Communication Objects number		1 (range from 1 to 16)
Activate from bus		no / yes
<i>The parameters allows to activate / deactivate the timer through a telegram coming from a supervisor on the bus.</i>		

Object name	Conditions	Dimens.	Flags	DPT	No. Comm. Obj.
Presence simulation (X)		1 bit	CRWTU-	[1.001] switch	616, 617, 618, 619, 620, 621, 622, 623, 624, 625, 626, 627, 628, 629, 630, 631
<i>Each of the communication objects must be associated through its group address to the corresponding communication objects of the actuators which are used to put the presence simulation to effect.</i>					
Presence simulation activation	Parameter Activate from bus = yes	1 bit	C-W---	[1.001] switch	632

14.2.3 Alarms

The Service ⇒ Alarms tab is active in ETS application program if the externally generated alarm visualization has been enabled in the Touch&See: *Pages configuration* ⇒ Alarms = enabled.

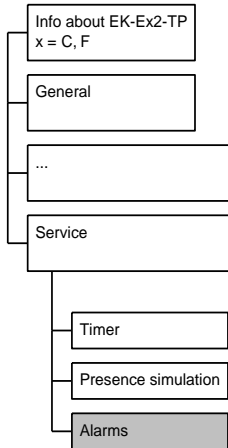

i The Alarms page displays both the alarms generated by external events (configured in the Service tab) and the alarms internally generated due to integrated sensors fault or when the update of the communication object related to the external sensors goes into timeout. By keeping the Alarm page disabled, the communication objects related to the Externally generated alarms will not be displayed, but it will still be possible to display the internally generated alarms (if timeouts are not disabled by setting their values = 00:00:00).

Parameter name	Conditions	Values
Alarm (X)		disabled / enabled
Text	Alarm (X) = enabled	ASCII text, max. 28 characters
	<i>The maximum length of each text string is 28 characters in standard ASCII code. If the Unicode (UTF-8) character encoding is used, the available string size might be smaller. The strings are static, i.e. they do not change according to the general language setting of the device.</i>	
Alarm condition	Alarm (X) = enabled	false / true
	<i>Alarm condition = true: alarm is considered incoming when the 1-bit communication object = 1; Alarm condition = false: alarm is considered incoming when the 1-bit communication object = 0.</i>	

Object name	Conditions	Dimens.	Flags	DPT	No. Comm. Obj.
Alarm (X)	Parameter Alarm (X) = enabled	1 bit	C-W---	[1.005] alarm	596, 597, 598, 599, 600, 601, 602, 603, 604, 605, 606, 607, 608, 609, 610, 611, 612, 613, 614, 615

15. Appendix

15.1 KNX communication objects summary

The following table shows a list of the KNX communication objects with the corresponding *Date Point Types* (DPT) defined by the ETS application program based on the performed configuration. The list is sorted by object number: if same objects are related to different inputs, the first object or pushbutton will be shown.

The communication objects marked with the symbol (**) are only available in EK-EF2-TP.

Object number (X = channel number)	Dimension	Flags	DPT	OC Number(s)
Date and time	8 Bytes	-WC---	[19.001] date time	1
Date	3 Bytes	-WC---	[11.001] date	2
Time	3 Bytes	-WC---	[10.001] time of day	3
Date and time	8 Bytes	R-CT--	[19.001] date time	4
Date	3 Bytes	R-CT--	[11.001] date	5
Time	3 Bytes	R-CT--	[10.001] time of day	6
Leds intensity percentage (**)	1 Byte	-WC---	[5.001] percentage (0..100%)	10
Temperature value (**)	2 Bytes	R-CT--	[9.001] temperature (°C)	12
Pushbutton X – Switching command	1 Bit	RWCTU-	[1.001] switch	22, 36, 54, 68, 86, 100, 118, 132, 150, 164, 182, 196, 214, 228, 246, 260, 278, 292, 310, 324, 342, 356, 374, 388, 406, 420, 438, 452, 470, 484, 502, 516
Pushbutton X – Dimming up / down / stop command	4 Bit	R-CT--	[3.007] dimming control, [3.008] blind control	23, 37, 55, 69, 87, 101, 119, 133, 151, 165, 183, 197, 215, 229, 247, 261, 279, 293, 311, 325, 343, 357, 375, 389, 407, 421, 439, 453, 471, 485, 503, 517
Pushbutton X – Dedicated stop command	1 Bit	RWCTU-	[1.017] trigger	22, 36, 54, 68, 86, 100, 118, 132, 150, 164, 182, 196, 214, 228, 246, 260, 278, 292, 310, 324, 342, 356, 374, 388, 406, 420, 438, 452, 470, 484, 502, 516
Pushbutton X – Stop-step up / down command	1 Bit	R-CT--	[1.007] step	24, 38, 56, 70, 88, 102, 120, 134, 152, 166, 184, 198, 216, 230, 248, 262, 280, 294, 312, 326, 344, 358, 376, 390, 408, 422, 440, 454, 472, 486, 504, 518

Object number (X = channel number)	Dimension	Flags	DPT	OC Number(s)
Pushbutton X – Up / down command	1 Bit	RWCTU-	[1.008] up / down	25, 39, 57, 71, 89, 103, 121, 135, 153, 167, 185, 199, 217, 231, 249, 263, 281, 295, 313, 327, 345, 359, 377, 391, 409, 423, 441, 455, 473, 487, 505, 519
Pushbutton X – Scene number	1 Byte	RWCTU-	[17.001] scene number, [18.001] scene control	26, 40, 58, 72, 90, 104, 122, 136, 154, 168, 186, 200, 218, 232, 250, 264, 282, 296, 314, 328, 346, 360, 378, 392, 410, 424, 442, 456, 474, 488, 506, 520
Pushbutton X – Lock command	1 Bit	-WC---	[1.003] enable	13, 27, 45, 59, 77, 91, 109, 123, 141, 155, 173, 187, 205, 219, 237, 251, 269, 283, 301, 315, 333, 347, 365, 379, 397, 411, 429, 443, 461, 475, 493, 507
Pushbuttons (X) and (X+1) – Switching command	1 Bit	RWCTU-	[1.001] switch	22, 54, 86, 118, 150, 182, 214, 246, 278, 310, 342, 374, 406, 438, 470, 502
Pushbuttons (X) and (X+1) – Dimming up / down / stop command	4 Bit	R-CT--	[3.007] dimming control, [3.008] blind control	23, 55, 87, 119, 151, 183, 215, 247, 279, 311, 343, 375, 407, 439, 471, 503,
Pushbuttons (X) and (X+1) – Dedicated stop command	1 Bit	RWCTU-	[1.017] trigger	22, 54, 86, 118, 150, 182, 214, 246, 278, 310, 342, 374, 406, 438, 470, 502
Pushbuttons (X) and (X+1) – Stop-step up / down command	1 Bit	R-CT--	[1.007] step	24, 56, 88, 120, 152, 184, 216, 248, 280, 312, 344, 376, 408, 440, 472, 504
Pushbuttons (X) and (X+1) – Up / down command	1 Bit	RWCTU-	[1.008] up / down	25, 57, 89, 121, 153, 185, 217, 249, 281, 313, 345, 377, 409, 441, 473, 505
Pushbuttons (X) and (X+1) – Lock command	1 Bit	-WC---	[1.003] enable	13, 45, 77, 109, 141, 173, 205, 237, 269, 301, 333, 365, 397, 429, 461, 493
Pushbutton X – Led blue command	1 Bit	RWCTU-	[1.001] switch	41, 43, 73, 75, 105, 107, 137, 139, 169, 171, 201, 203, 233, 235, 275, 277, 307, 309, 339, 341, 371, 373, 403, 405, 435, 437, 467, 469, 499, 501, 531, 533

Object number (X = channel number)	Dimension	Flags	DPT	OC Number(s)
Pushbutton X – Led green command	1 Bit	RWCTU-	[1.001] switch	42, 44, 74, 76, 106, 108, 138, 140, 170, 172, 202, 204, 234, 236, 276, 278, 308, 310, 340, 342, 372, 374, 404, 406, 436, 438, 468, 470, 500, 502, 532, 534
Pushbutton X – Switching status 1-bit object 1	1 Bit	RWCTU-	[1.001] switch	14, 28, 46, 60, 78, 92, 110, 124, 142, 156, 174, 188, 206, 220, 238, 252, 270, 284, 302, 316, 334, 348, 366, 380, 398, 412, 430, 444, 462, 476, 494, 508
Pushbutton X – Switching status 1-bit object 2	1 Bit	RWCTU-	[1.001] switch	15, 29, 47, 61, 79, 93, 111, 125, 143, 157, 175, 189, 207, 221, 239, 253, 271, 285, 303, 317, 335, 349, 367, 381, 399, 413, 431, 445, 463, 477, 495, 509
Pushbutton X – Switching status 1-bit object 3	1 Bit	RWCTU-	[1.001] switch	16, 30, 48, 62, 80, 94, 112, 126, 144, 158, 176, 190, 208, 222, 240, 254, 272, 286, 304, 318, 336, 350, 368, 382, 400, 414, 432, 446, 464, 478, 496, 510
Pushbutton X – Switching status 1-bit object 4	1 Bit	RWCTU-	[1.001] switch	17, 31, 49, 63, 81, 95, 113, 127, 145, 159, 177, 191, 209, 223, 241, 255, 273, 287, 305, 319, 337, 351, 369, 383, 401, 415, 433, 447, 465, 479, 497, 511
Pushbutton X – Switching status 1-bit object 5	1 Bit	RWCTU-	[1.001] switch	18, 32, 50, 64, 82, 96, 114, 128, 146, 160, 178, 192, 210, 224, 242, 256, 274, 288, 306, 320, 338, 352, 370, 384, 402, 416, 434, 448, 466, 480, 498, 512
Pushbutton X – Switching status 1-bit object 6	1 Bit	RWCTU-	[1.001] switch	19, 33, 51, 65, 83, 97, 115, 129, 147, 161, 179, 193, 211, 225, 243, 257, 275, 289, 307, 321, 339, 353, 371, 385, 403, 417, 435, 449, 467, 481, 499, 513

Object number (X = channel number)	Dimension	Flags	DPT	OC Number(s)
Pushbutton X – Switching status 1-bit object 7	1 Bit	RWCTU-	[1.001] switch	20, 34, 52, 66, 84, 98, 116, 130, 148, 162, 180, 194, 212, 226, 244, 258, 276, 290, 308, 322, 340, 354, 372, 386, 404, 418, 436, 450, 468, 482, 500, 514
Pushbutton X – Switching status 1-bit object 8	1 Bit	RWCTU-	[1.001] switch	21, 35, 53, 67, 85, 99, 117, 131, 149, 163, 181, 195, 213, 227, 245, 259, 277, 291, 309, 323, 341, 355, 373, 387, 405, 419, 437, 451, 469, 483, 501, 515
Pushbutton X – Switching status 2-bit object 1	2 Bit	RWCTU-	[2.001] switch control, [2.008] direction control 1	14, 28, 46, 60, 78, 92, 110, 124, 142, 156, 174, 188, 206, 220, 238, 252, 270, 284, 302, 316, 334, 348, 366, 380, 398, 412, 430, 444, 462, 476, 494, 508
Pushbutton X – Switching status 2-bit object 2	2 Bit	RWCTU-	[2.001] switch control, [2.008] direction control 1	15, 29, 47, 61, 79, 93, 111, 125, 143, 157, 175, 189, 207, 221, 239, 253, 271, 285, 303, 317, 335, 349, 367, 381, 399, 413, 431, 445, 463, 477, 495, 509
Pushbutton X – Switching status 2-bit object 3	2 Bit	RWCTU-	[2.001] switch control, [2.008] direction control 1	16, 30, 48, 62, 80, 94, 112, 126, 144, 158, 176, 190, 208, 222, 240, 254, 272, 286, 304, 318, 336, 350, 368, 382, 400, 414, 432, 446, 464, 478, 496, 510
Pushbutton X – Switching status 2-bit object 4	2 Bit	RWCTU-	[2.001] switch control, [2.008] direction control 1	17, 31, 49, 63, 81, 95, 113, 127, 145, 159, 177, 191, 209, 223, 241, 255, 273, 287, 305, 319, 337, 351, 369, 383, 401, 415, 433, 447, 465, 479, 497, 511
Pushbutton X – Switching status 2-bit object 5	2 Bit	RWCTU-	[2.001] switch control, [2.008] direction control 1	18, 32, 50, 64, 82, 96, 114, 128, 146, 160, 178, 192, 210, 224, 242, 256, 274, 288, 306, 320, 338, 352, 370, 384, 402, 416, 434, 448, 466, 480, 498, 512

Object number (X = channel number)	Dimension	Flags	DPT	OC Number(s)
Pushbutton X – Switching status 2-bit object 6	2 Bit	RWCTU-	[2.001] switch control, [2.008] direction control 1	19, 33, 51, 65, 83, 97, 115, 129, 147, 161, 179, 193, 211, 225, 243, 257, 275, 289, 307, 321, 339, 353, 371, 385, 403, 417, 435, 449, 467, 481, 499, 513
Pushbutton X – Switching status 2-bit object 7	2 Bit	RWCTU-	[2.001] switch control, [2.008] direction control 1	20, 34, 52, 66, 84, 98, 116, 130, 148, 162, 180, 194, 212, 226, 244, 258, 276, 290, 308, 322, 340, 354, 372, 386, 404, 418, 436, 450, 468, 482, 500, 514
Pushbutton X – Switching status 2-bit object 8	2 Bit	RWCTU-	[2.001] switch control, [2.008] direction control 1	21, 35, 53, 67, 85, 99, 117, 131, 149, 163, 181, 195, 213, 227, 245, 259, 277, 291, 309, 323, 341, 355, 373, 387, 405, 419, 437, 451, 469, 483, 501, 515
Pushbutton X – Switching status 1-unsigned byte object 1	1 Byte	RWCTU-	[5.010] counter pulses (0..255)	14, 28, 46, 60, 78, 92, 110, 124, 142, 156, 174, 188, 206, 220, 238, 252, 270, 284, 302, 316, 334, 348, 366, 380, 398, 412, 430, 444, 462, 476, 494, 508
Pushbutton X – Switching status 1-unsigned byte object 2	1 Byte	RWCTU-	[5.001] percentage (0..100%) [5.010] counter pulses (0..255)	15, 29, 47, 61, 79, 93, 111, 125, 143, 157, 175, 189, 207, 221, 239, 253, 271, 285, 303, 317, 335, 349, 367, 381, 399, 413, 431, 445, 463, 477, 495, 509
Pushbutton X – Switching status 1-unsigned byte object 3	1 Byte	RWCTU-	[5.001] percentage (0..100%) [5.010] counter pulses (0..255)	16, 30, 48, 62, 80, 94, 112, 126, 144, 158, 176, 190, 208, 222, 240, 254, 272, 286, 304, 318, 336, 350, 368, 382, 400, 414, 432, 446, 464, 478, 496, 510
Pushbutton X – Switching status 1-unsigned byte object 4	1 Byte	RWCTU-	[5.001] percentage (0..100%) [5.010] counter pulses (0..255)	17, 31, 49, 63, 81, 95, 113, 127, 145, 159, 177, 191, 209, 223, 241, 255, 273, 287, 305, 319, 337, 351, 369, 383, 401, 415, 433, 447, 465, 479, 497, 511

Object number (X = channel number)	Dimension	Flags	DPT	OC Number(s)
Pushbutton X – Switching status 1-unsigned byte object 5	1 Byte	RWCTU-	[5.001] percentage (0..100%) [5.010] counter pulses (0..255)	18, 32, 50, 64, 82, 96, 114, 128, 146, 160, 178, 192, 210, 224, 242, 256, 274, 288, 306, 320, 338, 352, 370, 384, 402, 416, 434, 448, 466, 480, 498, 512
Pushbutton X – Switching status 1-unsigned byte object 6	1 Byte	RWCTU-	[5.001] percentage (0..100%) [5.010] counter pulses (0..255)	19, 33, 51, 65, 83, 97, 115, 129, 147, 161, 179, 193, 211, 225, 243, 257, 275, 289, 307, 321, 339, 353, 371, 385, 403, 417, 435, 449, 467, 481, 499, 513
Pushbutton X – Switching status 1-unsigned byte object 7	1 Byte	RWCTU-	[5.001] percentage (0..100%) [5.010] counter pulses (0..255)	20, 34, 52, 66, 84, 98, 116, 130, 148, 162, 180, 194, 212, 226, 244, 258, 276, 290, 308, 322, 340, 354, 372, 386, 404, 418, 436, 450, 468, 482, 500, 514
Pushbutton X – Switching status 1-unsigned byte object 8	1 Byte	RWCTU-	[5.001] percentage (0..100%) [5.010] counter pulses (0..255)	21, 35, 53, 67, 85, 99, 117, 131, 149, 163, 181, 195, 213, 227, 245, 259, 277, 291, 309, 323, 341, 355, 373, 387, 405, 419, 437, 451, 469, 483, 501, 515
Pushbutton X – Switching status 1-signed byte object 1	1 Byte	RWCTU-	[6.001] percentage (- 128..127%), [6.010] counter pulses (- 128..127%)	14, 28, 46, 60, 78, 92, 110, 124, 142, 156, 174, 188, 206, 220, 238, 252, 270, 284, 302, 316, 334, 348, 366, 380, 398, 412, 430, 444, 462, 476, 494, 508
Pushbutton X – Switching status 1-signed byte object 2	1 Byte	RWCTU-	[6.001] percentage (- 128..127%), [6.010] counter pulses (- 128..127%)	15, 29, 47, 61, 79, 93, 111, 125, 143, 157, 175, 189, 207, 221, 239, 253, 271, 285, 303, 317, 335, 349, 367, 381, 399, 413, 431, 445, 463, 477, 495, 509
Pushbutton X – Switching status 1-signed byte object 3	1 Byte	RWCTU-	[6.001] percentage (- 128..127%), [6.010] counter pulses (- 128..127%)	16, 30, 48, 62, 80, 94, 112, 126, 144, 158, 176, 190, 208, 222, 240, 254, 272, 286, 304, 318, 336, 350, 368, 382, 400, 414, 432, 446, 464, 478, 496, 510

Object number (X = channel number)	Dimension	Flags	DPT	OC Number(s)
Pushbutton X – Switching status 1-signed byte object 4	1 Byte	RWCTU-	[6.001] percentage (-128..127%), [6.010] counter pulses (-128..127%)	17, 31, 49, 63, 81, 95, 113, 127, 145, 159, 177, 191, 209, 223, 241, 255, 273, 287, 305, 319, 337, 351, 369, 383, 401, 415, 433, 447, 465, 479, 497, 511
Pushbutton X – Switching status 1-signed byte object 5	1 Byte	RWCTU-	[6.001] percentage (-128..127%), [6.010] counter pulses (-128..127%)	18, 32, 50, 64, 82, 96, 114, 128, 146, 160, 178, 192, 210, 224, 242, 256, 274, 288, 306, 320, 338, 352, 370, 384, 402, 416, 434, 448, 466, 480, 498, 512
Pushbutton X – Switching status 1-signed byte object 6	1 Byte	RWCTU-	[6.001] percentage (-128..127%), [6.010] counter pulses (-128..127%)	19, 33, 51, 65, 83, 97, 115, 129, 147, 161, 179, 193, 211, 225, 243, 257, 275, 289, 307, 321, 339, 353, 371, 385, 403, 417, 435, 449, 467, 481, 499, 513
Pushbutton X – Switching status 1-signed byte object 7	1 Byte	RWCTU-	[6.001] percentage (-128..127%), [6.010] counter pulses (-128..127%)	20, 34, 52, 66, 84, 98, 116, 130, 148, 162, 180, 194, 212, 226, 244, 258, 276, 290, 308, 322, 340, 354, 372, 386, 404, 418, 436, 450, 468, 482, 500, 514
Pushbutton X – Switching status 1-signed byte object 8	1 Byte	RWCTU-	[6.001] percentage (-128..127%), [6.010] counter pulses (-128..127%)	21, 35, 53, 67, 85, 99, 117, 131, 149, 163, 181, 195, 213, 227, 245, 259, 277, 291, 309, 323, 341, 355, 373, 387, 405, 419, 437, 451, 469, 483, 501, 515
Pushbutton X – Switching status 2-unsigned bytes object 1	2 Bytes	RWCTU-	[7.001] pulses	14, 28, 46, 60, 78, 92, 110, 124, 142, 156, 174, 188, 206, 220, 238, 252, 270, 284, 302, 316, 334, 348, 366, 380, 398, 412, 430, 444, 462, 476, 494, 508
Pushbutton X – Switching status 2-unsigned byte object 2	2 Bytes	RWCTU-	[7.001] pulses	15, 29, 47, 61, 79, 93, 111, 125, 143, 157, 175, 189, 207, 221, 239, 253, 271, 285, 303, 317, 335, 349, 367, 381, 399, 413, 431, 445, 463, 477, 495, 509

Object number (X = channel number)	Dimension	Flags	DPT	OC Number(s)
Pushbutton X – Switching status 2-unsigned byte object 3	2 Bytes	RWCTU-	[7.001] pulses	16, 30, 48, 62, 80, 94, 112, 126, 144, 158, 176, 190, 208, 222, 240, 254, 272, 286, 304, 318, 336, 350, 368, 382, 400, 414, 432, 446, 464, 478, 496, 510
Pushbutton X – Switching status 2-unsigned byte object 4	2 Bytes	RWCTU-	[7.001] pulses	17, 31, 49, 63, 81, 95, 113, 127, 145, 159, 177, 191, 209, 223, 241, 255, 273, 287, 305, 319, 337, 351, 369, 383, 401, 415, 433, 447, 465, 479, 497, 511
Pushbutton X – Switching status 2-unsigned byte object 5	2 Bytes	RWCTU-	[7.001] pulses	18, 32, 50, 64, 82, 96, 114, 128, 146, 160, 178, 192, 210, 224, 242, 256, 274, 288, 306, 320, 338, 352, 370, 384, 402, 416, 434, 448, 466, 480, 498, 512
Pushbutton X – Switching status 2-unsigned byte object 6	2 Bytes	RWCTU-	[7.001] pulses	19, 33, 51, 65, 83, 97, 115, 129, 147, 161, 179, 193, 211, 225, 243, 257, 275, 289, 307, 321, 339, 353, 371, 385, 403, 417, 435, 449, 467, 481, 499, 513
Pushbutton X – Switching status 2-unsigned byte object 7	2 Bytes	RWCTU-	[7.001] pulses	20, 34, 52, 66, 84, 98, 116, 130, 148, 162, 180, 194, 212, 226, 244, 258, 276, 290, 308, 322, 340, 354, 372, 386, 404, 418, 436, 450, 468, 482, 500, 514
Pushbutton X – Switching status 2-unsigned byte object 8	2 Bytes	RWCTU-	[7.001] pulses	21, 35, 53, 67, 85, 99, 117, 131, 149, 163, 181, 195, 213, 227, 245, 259, 277, 291, 309, 323, 341, 355, 373, 387, 405, 419, 437, 451, 469, 483, 501, 515
Pushbutton X – Switching status 2-signed bytes object 1	2 Bytes	RWCTU-	[8.001] pulses difference	14, 28, 46, 60, 78, 92, 110, 124, 142, 156, 174, 188, 206, 220, 238, 252, 270, 284, 302, 316, 334, 348, 366, 380, 398, 412, 430, 444, 462, 476, 494, 508

Object number (X = channel number)	Dimension	Flags	DPT	OC Number(s)
Pushbutton X – Switching status 2-signed byte object 2	2 Bytes	RWCTU-	[8.001] pulses difference	15, 29, 47, 61, 79, 93, 111, 125, 143, 157, 175, 189, 207, 221, 239, 253, 271, 285, 303, 317, 335, 349, 367, 381, 399, 413, 431, 445, 463, 477, 495, 509
Pushbutton X – Switching status 2-signed byte object 3	2 Bytes	RWCTU-	[8.001] pulses difference	16, 30, 48, 62, 80, 94, 112, 126, 144, 158, 176, 190, 208, 222, 240, 254, 272, 286, 304, 318, 336, 350, 368, 382, 400, 414, 432, 446, 464, 478, 496, 510
Pushbutton X – Switching status 2-signed byte object 4	2 Bytes	RWCTU-	[8.001] pulses difference	17, 31, 49, 63, 81, 95, 113, 127, 145, 159, 177, 191, 209, 223, 241, 255, 273, 287, 305, 319, 337, 351, 369, 383, 401, 415, 433, 447, 465, 479, 497, 511
Pushbutton X – Switching status 2-signed byte object 5	2 Bytes	RWCTU-	[8.001] pulses difference	18, 32, 50, 64, 82, 96, 114, 128, 146, 160, 178, 192, 210, 224, 242, 256, 274, 288, 306, 320, 338, 352, 370, 384, 402, 416, 434, 448, 466, 480, 498, 512
Pushbutton X – Switching status 2-signed byte object 6	2 Bytes	RWCTU-	[8.001] pulses difference	19, 33, 51, 65, 83, 97, 115, 129, 147, 161, 179, 193, 211, 225, 243, 257, 275, 289, 307, 321, 339, 353, 371, 385, 403, 417, 435, 449, 467, 481, 499, 513
Pushbutton X – Switching status 2-signed byte object 7	2 Bytes	RWCTU-	[8.001] pulses difference	20, 34, 52, 66, 84, 98, 116, 130, 148, 162, 180, 194, 212, 226, 244, 258, 276, 290, 308, 322, 340, 354, 372, 386, 404, 418, 436, 450, 468, 482, 500, 514
Pushbutton X – Switching status 2-signed byte object 8	2 Bytes	RWCTU-	[8.001] pulses difference	21, 35, 53, 67, 85, 99, 117, 131, 149, 163, 181, 195, 213, 227, 245, 259, 277, 291, 309, 323, 341, 355, 373, 387, 405, 419, 437, 451, 469, 483, 501, 515

Object number (X = channel number)	Dimension	Flags	DPT	OC Number(s)
Pushbutton X – Switching status 2-bytes floating value object 1	2 Bytes	RWCTU-	[9.xxx]	14, 28, 46, 60, 78, 92, 110, 124, 142, 156, 174, 188, 206, 220, 238, 252, 270, 284, 302, 316, 334, 348, 366, 380, 398, 412, 430, 444, 462, 476, 494, 508
Pushbutton X – Switching status 2-bytes floating value object 2	2 Bytes	RWCTU-	[9.xxx]	15, 29, 47, 61, 79, 93, 111, 125, 143, 157, 175, 189, 207, 221, 239, 253, 271, 285, 303, 317, 335, 349, 367, 381, 399, 413, 431, 445, 463, 477, 495, 509
Pushbutton X – Switching status 2-bytes floating value object 3	2 Bytes	RWCTU-	[9.xxx]	16, 30, 48, 62, 80, 94, 112, 126, 144, 158, 176, 190, 208, 222, 240, 254, 272, 286, 304, 318, 336, 350, 368, 382, 400, 414, 432, 446, 464, 478, 496, 510
Pushbutton X – Switching status 2-bytes floating value object 4	2 Bytes	RWCTU-	[9.xxx]	17, 31, 49, 63, 81, 95, 113, 127, 145, 159, 177, 191, 209, 223, 241, 255, 273, 287, 305, 319, 337, 351, 369, 383, 401, 415, 433, 447, 465, 479, 497, 511
Pushbutton X – Switching status 2-bytes floating value object 5	2 Bytes	RWCTU-	[9.xxx]	18, 32, 50, 64, 82, 96, 114, 128, 146, 160, 178, 192, 210, 224, 242, 256, 274, 288, 306, 320, 338, 352, 370, 384, 402, 416, 434, 448, 466, 480, 498, 512
Pushbutton X – Switching status 2-bytes floating value object 6	2 Bytes	RWCTU-	[9.xxx]	19, 33, 51, 65, 83, 97, 115, 129, 147, 161, 179, 193, 211, 225, 243, 257, 275, 289, 307, 321, 339, 353, 371, 385, 403, 417, 435, 449, 467, 481, 499, 513
Pushbutton X – Switching status 2-bytes floating value object 7	2 Bytes	RWCTU-	[9.xxx]	20, 34, 52, 66, 84, 98, 116, 130, 148, 162, 180, 194, 212, 226, 244, 258, 276, 290, 308, 322, 340, 354, 372, 386, 404, 418, 436, 450, 468, 482, 500, 514

Object number (X = channel number)	Dimension	Flags	DPT	OC Number(s)
Pushbutton X – Switching status 2-bytes floating value object 8	2 Bytes	RWCTU-	[9.xxx]	21, 35, 53, 67, 85, 99, 117, 131, 149, 163, 181, 195, 213, 227, 245, 259, 277, 291, 309, 323, 341, 355, 373, 387, 405, 419, 437, 451, 469, 483, 501, 515
Rocker xA/B – Switching command (**)	1 Bit	RWCTU-	[1.001] switch	534, 548, 566, 580
Rocker xA/B – Dimming up / down / stop command (**)	4 Bit	R-CT--	[3.007] dimming control, [3.008] blind control	535, 549, 567, 581
Rocker xA/B – Dedicated stop command (**)	1 Bit	RWCTU-	[1.017] trigger	534, 548, 566, 580
Rocker xA/B – Stop-step up / down command (**)	1 Bit	R-CT--	[1.007] step	536, 550, 568, 582
Rocker xA/B – Up / down command (**)	1 Bit	RWCTU-	[1.008] up / down	537, 551, 569, 583
Rocker xA/B – scene number (**)	1 Byte	RWCTU-	[17.001] scene number, [18.001] scene control	538, 552, 570, 584
Rocker xA/B – Lock command (**)	1 Bit	-WC---	[1.003] enable	525, 539, 557, 571
Rocker (x) – Switching command (**)	1 Bit	RWCTU-	[1.001] switch	534, 566
Rocker (x) – Dimming up / down / stop command (**)	4 Bit	R-CT--	[3.007] dimming control, [3.008] blind control	535, 567
Rocker (x) – Dedicated stop command (**)	1 Bit	RWCTU-	[1.017] trigger	534, 566
Rocker (x) – Stop-step up / down command (**)	1 Bit	R-CT--	[1.007] step	536, 568
Rocker (x) – Up / down command (**)	1 Bit	RWCTU-	[1.008] up / down	537, 569
Rocker (x) – Lock command (**)	1 Bit	-WC---	[1.003] enable	525, 557
Rocker (x) – Led blue A command (**)	1 Bit	RWCTU-	[1.001] switch	553, 585
Rocker (x) – Led green A command (**)	1 Bit	RWCTU-	[1.001] switch	554, 586
Rocker (x) – Led blue B command (**)	1 Bit	RWCTU-	[1.001] switch	555, 587
Rocker (x) – Led green B command (**)	1 Bit	RWCTU-	[1.001] switch	556, 588
Rocker xA/B – Switching status 1-bit object 1 (**)	1 Bit	RWCTU-	[1.001] switch	526, 540, 558, 572
Rocker xA/B – Switching status 1-bit object 2 (**)	1 Bit	RWCTU-	[1.001] switch	527, 541, 559, 573
Rocker xA/B – Switching status 1-bit object 3 (**)	1 Bit	RWCTU-	[1.001] switch	528, 542, 560, 574
Rocker xA/B – Switching status 1-bit object 4 (**)	1 Bit	RWCTU-	[1.001] switch	529, 543, 561, 575
Rocker xA/B – Switching status 1-bit object 5 (**)	1 Bit	RWCTU-	[1.001] switch	530, 544, 562, 576
Rocker xA/B – Switching status 1-bit object 6 (**)	1 Bit	RWCTU-	[1.001] switch	531, 545, 563, 577
Rocker xA/B – Switching status 1-bit object 7 (**)	1 Bit	RWCTU-	[1.001] switch	532, 546, 564, 578
Rocker xA/B – Switching status 1-bit object 8 (**)	1 Bit	RWCTU-	[1.001] switch	533, 547, 565, 579
Rocker xA/B – Switching status 2-bit object 1 (**)	2 Bit	RWCTU-	[2.001] switch control, [2.008] direction control 1	526, 540, 558, 572
Rocker xA/B – Switching status 2-bit object 2 (**)	2 Bit	RWCTU-	[2.001] switch control, [2.008] direction control 1	527, 541, 559, 573

Object number (X = channel number)	Dimension	Flags	DPT	OC Number(s)
Rocker xA/B – Switching status 2-bit object 3 (**)	2 Bit	RWCTU-	[2.001] switch control, [2.008] direction control 1	528, 542, 560, 574
Rocker xA/B – Switching status 2-bit object 4 (**)	2 Bit	RWCTU-	[2.001] switch control, [2.008] direction control 1	529, 543, 561, 575
Rocker xA/B – Switching status 2-bit object 5 (**)	2 Bit	RWCTU-	[2.001] switch control, [2.008] direction control 1	530, 544, 562, 576
Rocker xA/B – Switching status 2-bit object 6 (**)	2 Bit	RWCTU-	[2.001] switch control, [2.008] direction control 1	531, 545, 563, 577
Rocker xA/B – Switching status 2-bit object 7 (**)	2 Bit	RWCTU-	[2.001] switch control, [2.008] direction control 1	532, 546, 564, 578
Rocker xA/B – Switching status 2-bit object 8 (**)	2 Bit	RWCTU-	[2.001] switch control, [2.008] direction control 1	533, 547, 565, 579
Rocker xA/B – Switching status 1-unsigned byte object 1 (**)	1 Byte	RWCTU-	[5.010] counter pulses (0..255)	526, 540, 558, 572
Rocker xA/B – Switching status 1-unsigned byte object 2 (**)	1 Byte	RWCTU-	[5.001] percentage (0..100%) [5.010] counter pulses (0..255)	527, 541, 559, 573
Rocker xA/B – Switching status 1-unsigned byte object 3 (**)	1 Byte	RWCTU-	[5.001] percentage (0..100%) [5.010] counter pulses (0..255)	528, 542, 560, 574
Rocker xA/B – Switching status 1-unsigned byte object 4 (**)	1 Byte	RWCTU-	[5.001] percentage (0..100%) [5.010] counter pulses (0..255)	529, 543, 561, 575
Rocker xA/B – Switching status 1-unsigned byte object 5 (**)	1 Byte	RWCTU-	[5.001] percentage (0..100%) [5.010] counter pulses (0..255)	530, 544, 562, 576
Rocker xA/B – Switching status 1-unsigned byte object 6 (**)	1 Byte	RWCTU-	[5.001] percentage (0..100%) [5.010] counter pulses (0..255)	531, 545, 563, 577
Rocker xA/B – Switching status 1-unsigned byte object 7 (**)	1 Byte	RWCTU-	[5.001] percentage (0..100%) [5.010] counter pulses (0..255)	532, 546, 564, 578
Rocker xA/B – Switching status 1-unsigned byte object 8 (**)	1 Byte	RWCTU-	[5.001] percentage (0..100%) [5.010] counter pulses (0..255)	533, 547, 565, 579
Rocker xA/B – Switching status 1-signed byte object 1 (**)	1 Byte	RWCTU-	[6.001] percentage (-128..127%), [6.010] counter pulses (-128..127%)	526, 540, 558, 572
Rocker xA/B – Switching status 1-signed byte object 2 (**)	1 Byte	RWCTU-	[6.001] percentage (-128..127%), [6.010] counter pulses (-128..127%)	527, 541, 559, 573
Rocker xA/B – Switching status 1-signed byte object 3 (**)	1 Byte	RWCTU-	[6.001] percentage (-128..127%), [6.010] counter pulses (-128..127%)	528, 542, 560, 574
Rocker xA/B – Switching status 1-signed byte object 4 (**)	1 Byte	RWCTU-	[6.001] percentage (-128..127%), [6.010] counter pulses (-128..127%)	529, 543, 561, 575
Rocker xA/B – Switching status 1-signed byte object 5 (**)	1 Byte	RWCTU-	[6.001] percentage (-128..127%), [6.010] counter pulses (-128..127%)	530, 544, 562, 576
Rocker xA/B – Switching status 1-signed byte object 6 (**)	1 Byte	RWCTU-	[6.001] percentage (-128..127%), [6.010] counter pulses (-128..127%)	531, 545, 563, 577
Rocker xA/B – Switching status 1-signed byte object 7 (**)	1 Byte	RWCTU-	[6.001] percentage (-128..127%), [6.010] counter pulses (-128..127%)	532, 546, 564, 578
Rocker xA/B – Switching status 1-signed byte object 8 (**)	1 Byte	RWCTU-	[6.001] percentage (-128..127%), [6.010] counter pulses (-128..127%)	533, 547, 565, 579

Object number (X = channel number)	Dimension	Flags	DPT	OC Number(s)
Rocker xA/B – Switching status 2-unsigned bytes object 1 (**)	2 Bytes	RWCTU-	[7.001] pulses	526, 540, 558, 572
Rocker xA/B – Switching status 2-unsigned byte object 2 (**)	2 Bytes	RWCTU-	[7.001] pulses	527, 541, 559, 573
Rocker xA/B – Switching status 2-unsigned byte object 3 (**)	2 Bytes	RWCTU-	[7.001] pulses	528, 542, 560, 574
Rocker xA/B – Switching status 2-unsigned byte object 4 (**)	2 Bytes	RWCTU-	[7.001] pulses	529, 543, 561, 575
Rocker xA/B – Switching status 2-unsigned byte object 5 (**)	2 Bytes	RWCTU-	[7.001] pulses	530, 544, 562, 576
Rocker xA/B – Switching status 2-unsigned byte object 6 (**)	2 Bytes	RWCTU-	[7.001] pulses	531, 545, 563, 577
Rocker xA/B – Switching status 2-unsigned byte object 7 (**)	2 Bytes	RWCTU-	[7.001] pulses	532, 546, 564, 578
Rocker xA/B – Switching status 2-unsigned byte object 8 (**)	2 Bytes	RWCTU-	[7.001] pulses	533, 547, 565, 579
Rocker xA/B – Switching status 2-signed bytes object 1 (**)	2 Bytes	RWCTU-	[8.001] pulses difference	526, 540, 558, 572
Rocker xA/B – Switching status 2-signed byte object 2 (**)	2 Bytes	RWCTU-	[8.001] pulses difference	527, 541, 559, 573
Rocker xA/B – Switching status 2-signed byte object 3 (**)	2 Bytes	RWCTU-	[8.001] pulses difference	528, 542, 560, 574
Rocker xA/B – Switching status 2-signed byte object 4 (**)	2 Bytes	RWCTU-	[8.001] pulses difference	529, 543, 561, 575
Rocker xA/B – Switching status 2-signed byte object 5 (**)	2 Bytes	RWCTU-	[8.001] pulses difference	530, 544, 562, 576
Rocker xA/B – Switching status 2-signed byte object 6 (**)	2 Bytes	RWCTU-	[8.001] pulses difference	531, 545, 563, 577
Rocker xA/B – Switching status 2-signed byte object 7 (**)	2 Bytes	RWCTU-	[8.001] pulses difference	532, 546, 564, 578
Rocker xA/B – Switching status 2-signed byte object 8 (**)	2 Bytes	RWCTU-	[8.001] pulses difference	533, 547, 565, 579
Rocker xA/B – Switching status 2-bytes floating value object 1 (**)	2 Bytes	RWCTU-	[9.xxx]	526, 540, 558, 572
Rocker xA/B – Switching status 2-bytes floating value object 2 (**)	2 Bytes	RWCTU-	[9.xxx]	527, 541, 559, 573
Rocker xA/B – Switching status 2-bytes floating value object 3 (**)	2 Bytes	RWCTU-	[9.xxx]	528, 542, 560, 574
Rocker xA/B – Switching status 2-bytes floating value object 4 (**)	2 Bytes	RWCTU-	[9.xxx]	529, 543, 561, 575
Rocker xA/B – Switching status 2-bytes floating value object 5 (**)	2 Bytes	RWCTU-	[9.xxx]	530, 544, 562, 576
Rocker xA/B – Switching status 2-bytes floating value object 6 (**)	2 Bytes	RWCTU-	[9.xxx]	531, 545, 563, 577
Rocker xA/B – Switching status 2-bytes floating value object 7 (**)	2 Bytes	RWCTU-	[9.xxx]	532, 546, 564, 578
Rocker xA/B – Switching status 2-bytes floating value object 8 (**)	2 Bytes	RWCTU-	[9.xxx]	533, 547, 565, 579
Outside temperature	2 Bytes	-WC---	[9.001] temperature (°C)	589
Rain	1 Bit	-WC---	[1.002] boolean	590
Wind speed	1 Byte	-WC---	[20.014] wind force scale (0..12)	591
Wind speed	2 Bytes	-WC---	[9.028] wind speed (km / h)	591
Wind speed	2 Bytes	-WC---	[9.005] speed (m / s)	591
External humidity	2 Bytes	-WC---	[9.007] percentage (%)	592























Object number (X = channel number)	Dimension	Flags	DPT	OC Number(s)
External humidity	1 Byte	-WC---	[5.001] percentage (0..100%)	592
Atmospheric pressure	2 Bytes	-WC---	[9.006] pressure (Pa)	593
External brightness	2 Bytes	-WC---	[9.004] lux (Lux)	594
Twilight	1 Bit	-WC---	[1.002] boolean	595
Alarm 1	1 Bit	-WC---	[1.005] alarm	596
Alarm 2	1 Bit	-WC---	[1.005] alarm	597
Alarm 3	1 Bit	-WC---	[1.005] alarm	598
Alarm 4	1 Bit	-WC---	[1.005] alarm	599
Alarm 5	1 Bit	-WC---	[1.005] alarm	600
Alarm 6	1 Bit	-WC---	[1.005] alarm	601
Alarm 7	1 Bit	-WC---	[1.005] alarm	602
Alarm 8	1 Bit	-WC---	[1.005] alarm	603
Alarm 9	1 Bit	-WC---	[1.005] alarm	604
Alarm 10	1 Bit	-WC---	[1.005] alarm	605
Alarm 11	1 Bit	-WC---	[1.005] alarm	606
Alarm 12	1 Bit	-WC---	[1.005] alarm	607
Alarm 13	1 Bit	-WC---	[1.005] alarm	608
Alarm 14	1 Bit	-WC---	[1.005] alarm	609
Alarm 15	1 Bit	-WC---	[1.005] alarm	610
Alarm 16	1 Bit	-WC---	[1.005] alarm	611
Alarm 17	1 Bit	-WC---	[1.005] alarm	612
Alarm 18	1 Bit	-WC---	[1.005] alarm	613
Alarm 19	1 Bit	-WC---	[1.005] alarm	614
Alarm 20	1 Bit	-WC---	[1.005] alarm	615
Presence simulation 1	1 Bit	RWCTU-	[1.001] switch	616
Presence simulation 2	1 Bit	RWCTU-	[1.001] switch	617
Presence simulation 3	1 Bit	RWCTU-	[1.001] switch	618
Presence simulation 4	1 Bit	RWCTU-	[1.001] switch	619
Presence simulation 5	1 Bit	RWCTU-	[1.001] switch	620
Presence simulation 6	1 Bit	RWCTU-	[1.001] switch	621
Presence simulation 7	1 Bit	RWCTU-	[1.001] switch	622
Presence simulation 8	1 Bit	RWCTU-	[1.001] switch	623
Presence simulation 9	1 Bit	RWCTU-	[1.001] switch	624
Presence simulation 10	1 Bit	RWCTU-	[1.001] switch	625
Presence simulation 11	1 Bit	RWCTU-	[1.001] switch	626
Presence simulation 12	1 Bit	RWCTU-	[1.001] switch	627
Presence simulation 13	1 Bit	RWCTU-	[1.001] switch	628
Presence simulation 14	1 Bit	RWCTU-	[1.001] switch	629
Presence simulation 15	1 Bit	RWCTU-	[1.001] switch	630
Presence simulation 16	1 Bit	RWCTU-	[1.001] switch	631
Presence simulation activation	1 Bit	-WC---	[1.001] switch	632
Timer X – command 1-bit	1 Bit	R-CT--	[1.001] switch	633, 634, 635, 636, 637, 638, 639, 640, 641, 642
Timer X – command 2-bits	2 Bit	R-CT--	[2.001] switch control, [2.008] direction control 1	633, 634, 635, 636, 637, 638, 639, 640, 641, 642
Timer X – command 1-unsigned byte	1 Byte	R-CT--	[5.010] counter pulses (0..255)	633, 634, 635, 636, 637, 638, 639, 640, 641, 642
Timer X – command percentage	1 Byte	R-CT--	[5.001] percentage (0..100%)	633, 634, 635, 636, 637, 638, 639, 640, 641, 642
Timer X – command 1-signed byte	1 Byte	R-CT--	[6.001] percentage (-128..127%), [6.010] counter pulses (-128..127%)	633, 634, 635, 636, 637, 638, 639, 640, 641, 642
Timer X – command 2-unsigned bytes	2 Bytes	R-CT--	[7.001] pulses	633, 634, 635, 636, 637, 638, 639, 640, 641, 642
Timer X – command 2-signed bytes	2 Bytes	R-CT--	[8.001] pulses difference	633, 634, 635, 636, 637, 638, 639, 640, 641, 642

Object number (X = channel number)	Dimension	Flags	DPT	OC Number(s)
Timer X – command 2-bytes floating point value	2 Bytes	R-CT--	[9.xxx]	633, 634, 635, 636, 637, 638, 639, 640, 641, 642
Timer X – command scene number	1 Byte	R-CT--	[17.001] scene number	633, 634, 635, 636, 637, 638, 639, 640, 641, 642
Timer X – enable	1 Bit	-WC---	[1.003] enable	643, 644, 645, 646, 647, 648, 649, 650, 651, 652
Multimedia main power	1 Bit	R-CT--	[1.001] switch	653
Multimedia skip	1 Bit	R-CT--	[1.007] step	654
Multimedia fast forward-backward	4 Bit	R-CT--	[3.007] dimming control	655
Multimedia play-stop	1 Bit	R-CT--	[1.010] start / stop	656
Multimedia volume step	1 Bit	R-CT--	[1.007] step	657
Multimedia mute	1 Bit	R-CT--	[1.003] enable	658
Multimedia text	14 Bytes	-WC---	[16.000] Character String (ASCII), [16.001] Character String (ISO 8859-1)	659
Multimedia sleep enable	1 Bit	R-CT--	[1.003] enable	660
Multimedia sleeptime	2 Bytes	R-CT--	[7.006] time (min)	661
Multimedia bass step	1 Bit	R-CT--	[1.007] step	662
Multimedia treble step	1 Bit	R-CT--	[1.007] step	663
Multimedia balance step	1 Bit	R-CT--	[1.007] step	664
Zone n (1 to 8) - Temperature sensor 1	2 Bytes	-WC---	[9.001] temperature (°C)	665, 718, 771, 824, 877, 930, 983, 1036
Zone n (1 to 8) - Temperature sensor 2	2 Bytes	-WC---	[9.001] temperature (°C)	666, 719, 772, 825, 878, 931, 984, 1037
Zone n (1 to 8) - Temperature sensor 3	2 Bytes	-WC---	[9.001] temperature (°C)	667, 720, 773, 826, 879, 932, 985, 1038
Zone n (1 to 8) - Temperature sensor 4	2 Bytes	-WC---	[9.001] temperature (°C)	668, 721, 774, 827, 880, 933, 986, 1039
Zone n (1 to 8) – Weighted Temperature	2 Bytes	R-CT--	[9.1] DPT_Value_Temp	669, 722, 775, 828, 881, 934, 987, 1040
Zone n (1 to 8) - Humidity sensor	2 Bytes	-WC---	[9.007] percentage (%)	670, 723, 776, 829, 882, 935, 988, 1041
Zone n (1 to 8) - Humidity sensor (1 byte)	1 Byte	-WC---	[5.001] percentage (0..100%)	670, 723, 776, 829, 882, 935, 988, 1041
Zone n (1 to 8) - Air quality sensor	2 Bytes	-WC---	[9.008] parts / million (ppm)	671, 724, 777, 830, 883, 936, 989, 1042
Zone n (1 to 8) – Actual Setpoint	2 Bytes	R-CT--	[9.1] DPT_Value_Temp	672, 725, 778, 831, 884, 937, 990, 1043
Zone n (1 to 8) – Manual Setpoint	2 Bytes	RWCTU-	[9.001] temperature (°C)	674, 727, 780, 833, 886, 939, 992, 1045
Zone n (1 to 8) – Manual Setpoint Enable	1 Byte	RWCTU-	[1.11] DPT_State	675, 728, 781, 834, 887, 940, 993, 1046
Zone n (1 to 8) - Setpoint comfort heating	2 Bytes	RWCTU-	[9.001] temperature (°C)	676, 729, 782, 835, 888, 941, 994, 1047
Zone n (1 to 8) - Setpoint comfort cooling	2 Bytes	RWCTU-	[9.001] temperature (°C)	677, 730, 783, 836, 889, 942, 995, 1048
Zone n (1 to 8) - Setpoint standby heating	2 Bytes	RWCTU-	[9.001] temperature (°C)	678, 731, 784, 837, 890, 943, 996, 1049
Zone n (1 to 8) - Setpoint standby cooling	2 Bytes	RWCTU-	[9.001] temperature (°C)	679, 732, 785, 838, 891, 944, 997, 1050
Zone n (1 to 8) - Setpoint economy heating	2 Bytes	RWCTU-	[9.001] temperature (°C)	680, 733, 786, 839, 892, 945, 998, 1051
Zone n (1 to 8) - Setpoint economy cooling	2 Bytes	RWCTU-	[9.001] temperature (°C)	681, 734, 787, 840, 893, 946, 999, 1052
Zone n (1 to 8) - Setpoint building protection heating	2 Bytes	RWCTU-	[9.001] temperature (°C)	682, 735, 788, 841, 894, 947, 1000, 1053

























Object number (X = channel number)	Dimension	Flags	DPT	OC Number(s)
Zone n (1 to 8) - Setpoint building protection cooling	2 Bytes	RWCTU-	[9.001] temperature (°C)	683, 736, 789, 842, 895, 948, 1001, 1054
Zone n (1 to 8) - Heating out command	1 Bit	R-CT--	[1.001] switch	684, 737, 790, 843, 896, 949, 1002, 1055
Zone n (1 to 8) - Heating out command (1 byte)	1 Byte	R-CT--	[5.001] percentage (0..100%)	684, 737, 790, 843, 896, 949, 1002, 1055
Zone 1 – Heating and cooling out command	1 Bit	R-CT--	[1.001] switch	684, 737, 790, 843, 896, 949, 1002, 1055
Zone 1 – Heating and cooling out command (1 byte)	1 Byte	R-CT--	[5.001] percentage (0..100%)	684, 737, 790, 843, 896, 949, 1002, 1055
Zone n (1 to 8) - Auxiliary heating output command	1 Bit	R-CT--	[1.001] switch	685, 738, 791, 844, 897, 950, 1003, 1056
Zone n (1 to 8) - Auxiliary heating and cooling output command	1 Bit	R-CT--	[1.001] switch	685, 738, 791, 844, 897, 950, 1003, 1056
Zone n (1 to 8) - Cooling output command	1 Bit	R-CT--	[1.001] switch	686, 739, 792, 845, 898, 951, 1004, 1057
Zone n (1 to 8) - Cooling output command (1 byte)	1 Byte	R-CT--	[5.001] percentage (0..100%)	686, 739, 792, 845, 898, 951, 1004, 1057
Zone n (1 to 8) - Auxiliary cooling output command	1 Bit	R-CT--	[1.001] switch	687, 740, 793, 846, 899, 952, 1005, 1058
Zone n (1 to 8) - Auxiliary heating disable	1 Bit	-WC---	[1.003] enable	688, 741, 794, 847, 900, 953, 1006, 1059
Zone n (1 to 8) - Auxiliary cooling disable	1 Bit	-WC---	[1.003] enable	689, 742, 795, 848, 901, 954, 1007, 1060
Zone n (1 to 8) - Heating / cooling status out	1 Bit	R-CT--	[1.100] heating / cooling	690, 743, 796, 849, 902, 955, 1008, 1061
Zone n (1 to 8) - Heating / cooling status in	1 Bit	-WC---	[1.100] heating / cooling	691, 744, 797, 850, 903, 956, 1009, 1062
Zone n (1 to 8) - Fans speed counter	1 Byte	R-CT--	[5.10] DPT_Value_1_Ucount	692, 745, 798, 851, 904, 957, 1010, 1063
Zone n (1 to 8) - Fans speed off status	1 Bit	R-CT--	[1.1] DPT_Switch	693, 746, 799, 852, 905, 958, 1011, 1064
Zone n (1 to 8) - Fans speed continuous	1 Byte	R-CT--	[5.001] percentage (0..100%)	694, 747, 800, 853, 906, 959, 1012, 1064
Zone n (1 to 8) - Fans speed 1	1 Bit	R-CT--	[1.001] switch	694, 747, 800, 853, 906, 959, 1012, 1064
Zone n (1 to 8) - Fans speed 2	1 Bit	R-CT--	[1.001] switch	695, 748, 801, 854, 907, 960, 1013, 1065
Zone n (1 to 8) - Fans speed 3	1 Bit	R-CT--	[1.001] switch	696, 749, 802, 855, 908, 961, 1014, 1066
Zone n (1 to 8) - Fans manual continuous speed	1 Byte	-WC---	[5.1] DPT_Scaling	697, 750, 803, 856, 909, 962, 1015, 1067
Zone n (1 to 8) - Fans manual speed counter	1 Byte	-WC---	[5.10] DPT_Value_1_Ucount	698, 751, 804, 857, 910, 963, 1016, 1068
Zone n (1 to 8) - Fan manual mode activated	1 Bit	RWCTU-	[1.11] DPT_State	699, 752, 805, 858, 911, 964, 1017, 1069
Zone n (1 to 8) - Fans controller disable	1 Bit	-WC---	[1.002] boolean	700, 753, 806, 859, 912, 965, 1018, 1070
Zone n (1 to 8) - Water temperature threshold for fan start	2 Bytes	-WC---	[9.1] DPT_Value_Temp	701, 754, 807, 860, 913, 966, 1019, 1071
Zone n (1 to 8) - Window contact 1	1 Bit	-WC---	[1.019] window / door	702, 755, 808, 861, 914, 967, 1020, 1072
Zone n (1 to 8) - Window contact 2	1 Bit	-WC---	[1.019] window / door	703, 756, 809, 862, 915, 968, 1021, 1073
Zone n (1 to 8) - Window contact 3	1 Bit	-WC---	[1.019] window / door	704, 757, 810, 863, 916, 969, 1022, 1074
Zone n (1 to 8) - Window contact 4	1 Bit	-WC---	[1.019] window / door	705, 758, 811, 864, 917, 970, 1023, 1075

Object number (X = channel number)	Dimension	Flags	DPT	OC Number(s)
Zone n (1 to 8) - HVAC scene number	1 Byte	-WC---	[17.001] scene number, [18.001] scene control	706, 759, 812, 865, 918, 971, 1024, 1076
Zone n (1 to 8) - Presence sensor 1	1 Bit	-WC---	[1.018] occupancy	707, 760, 813, 866, 919, 972, 1025, 1077
Zone n (1 to 8) - Presence sensor 2	1 Bit	-WC---	[1.018] occupancy	708, 761, 814, 867, 920, 973, 1026, 1078
Zone n (1 to 8) - Presence sensor 3	1 Bit	-WC---	[1.018] occupancy	709, 762, 815, 868, 921, 974, 1027, 1079
Zone n (1 to 8) - Presence sensor 4	1 Bit	-WC---	[1.018] occupancy	710, 763, 816, 869, 922, 975, 1028, 1080
Zone n (1 to 8) - HVAC mode in	1 Byte	-WC---	[20.102] HVAC mode	711, 764, 817, 870, 923, 976, 1029, 1081
Zone n (1 to 8) - HVAC forced mode in	1 Byte	-WC---	[20.102] HVAC mode	712, 765, 818, 871, 924, 977, 1030, 1082
Zone n (1 to 8) - HVAC mode out	1 Byte	R-CT--	[20.102] HVAC mode	713, 766, 819, 872, 925, 978, 1031, 1083
Zone n (1 to 8) - HVAC manual mode in	2 Bytes	R-CT--	[9.001] temperature (°C)	714, 767, 820, 873, 926, 979, 1032, 1084
Zone n (1 to 8) - Chrono mode activated	1 Bit	RWCTU-	[1.11] DPT_State	715, 768, 821, 874, 927, 980, 1033, 1085
Zone n (1 to 8) - Temperature setpoint change lock	1 Bit	-WC---	[1.3] DPT_Enable	716, 769, 822, 875, 928, 981, 1034, 1086
Zone n (1 to 8) - Manual mode lock	1 Bit	-WC---	[1.3] DPT_Enable	717, 770, 823, 876, 929, 982, 1035, 1087

15.2 Pushbuttons custom symbols summary

00 – no symbol	 AA – buzzer	 AB – electric load	DO NOT DISTURB AC – do not disturb
 AD – garage door	 AE – gate	 AF – barrier	 AG – pedestrian entrance
 AH – irrigation	 AI – floor lamp	 AL – wall lamp	 AM – ceiling lamp
 AN – spotlight	 AO – staircase lighting	 AP – outdoor lighting	 AQ – lighting (generic)
 AR – dimming	MAKE UP ROOM AS – make up room	 AT – sound system	OFF AU – off
ON AV – on	 AZ – shutter, venetian blinds	 BA – indoor curtain	 BB – outdoor curtain
 BC – mobile electric load	 BD – comfort scene	 BE – irrigation scene	 BF – lighting scene

 BG – outdoor lighting scene	 BH – manual scene	 BI – night scene	 BL – off scene
 BM – on scene	 BN – shutters up scene	 BO – shutters down scene	 BP – curtains up scene
 BQ – curtains down scene	 BR – party scene	 BS – presence scene	 BT – standby scene
 BU – door lock	 BV – unlock	 BZ – lock	 CA – room service
 CB – service	 CC – differently abled	 CD – rescue	 CE – loudspeaker
 CF – temperature	 CG – temperature increase	 CH – temperature decrease	 CI – fan
 CL – Fans speed 1	 CM – Fans speed 2	 CN – Fans speed 3	 CO – increase (solid arrow)

 CP – decrease (solid arrow)	 CQ – increase (empty arrow)	 CR – decrease (empty arrow)	
ZZ – no symbol	 ZV – upper plus	 ZU – lower plus	 ZT – upper minus
 ZS – lower minus	 ZR – simple arrow up	 ZQ – simple arrow down	 ZP – empty arrow up
 ZO – empty arrow down	 ZN – solid arrow up	 ZM – solid arrow down	 ZL – upper empty circle
 ZI – lower empty circle	 ZH – upper solid circle	 ZG – lower solid circle	 ZF – upper triple empty circle
 ZE – lower triple empty circle	 ZD – upper triple solid circle	 ZC – lower triple solid circle	 ZB – left triple empty circle
 ZA – right triple empty circle	 VZ – left triple solid circle	 VV – right triple solid circle	

15.3 System alarms summary

Alarm code	Description
2	Integrated temperature sensor fault ⁶
100	Date and time timeout
102	Zone 1 - Timeout flow probe to start fan
103	Zone 2 - Timeout flow probe to start fan
104	Zone 3 - Timeout flow probe to start fan
105	Zone 4 - Timeout flow probe to start fan
106	Zone 5 - Timeout flow probe to start fan
107	Zone 6 - Timeout flow probe to start fan
108	Zone 7 - Timeout flow probe to start fan
109	Zone 8 - Timeout flow probe to start fan
110	Zone 1 - Timeout relative ambient humidity sensor
111	Zone 2 - Timeout relative ambient humidity sensor
112	Zone 3 - Timeout relative ambient humidity sensor
113	Zone 4 - Timeout relative ambient humidity sensor
114	Zone 5 - Timeout relative ambient humidity sensor
115	Zone 6 - Timeout relative ambient humidity sensor
116	Zone 7 - Timeout relative ambient humidity sensor
117	Zone 8 - Timeout relative ambient humidity sensor
118	Timeout Outside temperature sensor meteo page
119	Timeout Rain sensor meteo page
120	Timeout Wind speed sensor meteo page
121	Timeout relative humidity sensor esterna meteo page
122	Timeout External pressure sensor meteo page
123	Timeout External brightness sensor meteo page
124	Timeout External twilight sensor meteo page
125	Zone 1 - Timeout External sensor 1 internal temperature
126	Zone 1 - Timeout External sensor 2 internal temperature
127	Zone 1 - Timeout External sensor 3 internal temperature
128	Zone 1 - Timeout External sensor 4 internal temperature
129	Zone 2 - Timeout External sensor 1 internal temperature
130	Zone 2 - Timeout External sensor 2 internal temperature
131	Zone 2 - Timeout External sensor 3 internal temperature
132	Zone 2 - Timeout External sensor 4 internal temperature
133	Zone 3 - Timeout External sensor 1 internal temperature
134	Zone 3 - Timeout External sensor 2 internal temperature
135	Zone 3 - Timeout External sensor 3 internal temperature
136	Zone 3 - Timeout External sensor 4 internal temperature
137	Zone 4 - Timeout External sensor 1 internal temperature
138	Zone 4 - Timeout External sensor 2 internal temperature
139	Zone 4 - Timeout External sensor 3 internal temperature
130	Zone 4 - Timeout External sensor 4 internal temperature
141	Zone 5 - Timeout External sensor 1 internal temperature
142	Zone 5 - Timeout External sensor 2 internal temperature
143	Zone 5 - Timeout External sensor 3 internal temperature
144	Zone 5 - Timeout External sensor 4 internal temperature
145	Zone 6 - Timeout External sensor 1 internal temperature
146	Zone 6 - Timeout External sensor 2 internal temperature

⁶ Only for EK-EF2-TP version

Alarm code	Description
147	Zone 6 - Timeout External sensor 3 internal temperature
148	Zone 6 - Timeout External sensor 4 internal temperature
149	Zone 7 - Timeout External sensor 1 internal temperature
150	Zone 7 - Timeout External sensor 2 internal temperature
151	Zone 7 - Timeout External sensor 3 internal temperature
152	Zone 7 - Timeout External sensor 4 internal temperature
153	Zone 8 - Timeout External sensor 1 internal temperature
154	Zone 8 - Timeout External sensor 2 internal temperature
155	Zone 8 - Timeout External sensor 3 internal temperature
156	Zone 8 - Timeout External sensor 4 internal temperature
202	Zone 1 - Fault flow probe to start fan
203	Zone 2 - Fault flow probe to start fan
204	Zone 3 - Fault flow probe to start fan
205	Zone 4 - Fault flow probe to start fan
206	Zone 5 - Fault flow probe to start fan
207	Zone 6 - Fault flow probe to start fan
208	Zone 7 - Fault flow probe to start fan
209	Zone 8 - Fault flow probe to start fan
210	Zone 1 - Fault relative ambient humidity sensor
211	Zone 2 - Fault relative ambient humidity sensor
212	Zone 3 - Fault relative ambient humidity sensor
213	Zone 4 - Fault relative ambient humidity sensor
214	Zone 5 - Fault relative ambient humidity sensor
215	Zone 6 - Fault relative ambient humidity sensor
216	Zone 7 - Fault relative ambient humidity sensor
217	Zone 8 - Fault relative ambient humidity sensor
218	Fault Outside temperature sensor meteo page
220	Fault Wind speed sensor meteo page
221	Fault relative humidity sensor esterna meteo page
222	Fault External pressure meteo page
223	Fault External brightness sensor meteo page
225	Zone 1 - Fault External sensor 1 internal temperature
226	Zone 1 - Fault External sensor 2 internal temperature
227	Zone 1 - Fault External sensor 3 internal temperature
228	Zone 1 - Fault External sensor 4 internal temperature
229	Zone 2 - Fault External sensor 1 internal temperature
230	Zone 2 - Fault External sensor 2 internal temperature
231	Zone 2 - Fault External sensor 3 internal temperature
232	Zone 2 - Fault External sensor 4 internal temperature
233	Zone 3 - Fault External sensor 1 internal temperature
234	Zone 3 - Fault External sensor 2 internal temperature
235	Zone 3 - Fault External sensor 3 internal temperature
236	Zone 3 - Fault External sensor 4 internal temperature
237	Zone 4 - Fault External sensor 1 internal temperature
238	Zone 4 - Fault External sensor 2 internal temperature
239	Zone 4 - Fault External sensor 3 internal temperature
240	Zone 4 - Fault External sensor 4 internal temperature
241	Zone 5 - Fault External sensor 1 internal temperature
242	Zone 5 - Fault External sensor 2 internal temperature
243	Zone 5 - Fault External sensor 3 internal temperature
244	Zone 5 - Fault External sensor 4 internal temperature
245	Zone 6 - Fault External sensor 1 internal temperature

Alarm code	Description
246	Zone 6 - Fault External sensor 2 internal temperature
247	Zone 6 - Fault External sensor 3 internal temperature
248	Zone 6 - Fault External sensor 4 internal temperature
249	Zone 7 - Fault External sensor 1 internal temperature
250	Zone 7 - Fault External sensor 2 internal temperature
251	Zone 7 - Fault External sensor 3 internal temperature
252	Zone 7 - Fault External sensor 4 internal temperature
253	Zone 8 - Fault External sensor 1 internal temperature
254	Zone 8 - Fault External sensor 2 internal temperature
255	Zone 8 - Fault External sensor 3 internal temperature
256	Zone 8 - Fault External sensor 4 internal temperature

A fault of an external sensor connected through a communication object is detected through a “fault” telegram reception.

Timeout is an internal configurable parameter; when it occurs, the device detects the corresponding alarm and stops all functions associated to the sensors.

15.4 Technical characteristics

Feature	Value
Description and product code	Touch&See EK-EC2-TP and EK-EF2-TP
Device type	KNX S-mode bus device
Communication type	standard KNX TP1
Use	indoor dry rooms
Environmental conditions	<ul style="list-style-type: none"> • Working temperature: - 5 ... + 45°C • Storage temperature: - 25 ... + 55°C • Transport temperature: - 25 ... + 70°C • Relative humidity: 95% non condensing
Power supply	SELV 30 Vdc through KNX bus
Current consumption	40 mA
Auxiliary power supply	SELV 30 Vdc
Auxiliary power current consumption	120 mA
Display	Touch display TFT with backlight, size 3,5" (320 x 240 pixel), 65.536 colors
Integrated sensors	Temperature
Standby power source	Buffer battery to keep RTC power
Housing	Plastic material
Mounting	Wall-mounted on round flush-mounted wall box, diam. 60 mm
Protection degree	IP20 (according to EN 60529)
Climatic classification	3K5
Mechanical classification	3M2 (according to EN 50491-2)
Insulation class	III (according to EN 60664-1)
Pollution degree	2 (according to IEC 60664-1)
Regulation compliance	<ul style="list-style-type: none"> • KNX • CE marking: The product complies to the Low Voltage Directive (2006 / 95 / CE) and to the EMC directive (2004 / 108 / CE). • Tests carried out according to EN 50491-5-1:2010, EN 50491-5-2:2010
Weight	EK-EC2-TP: 100 g - EK-EF2-TP: 110 g
Dimensions (WxHxD)	EK-EC2-TP: 82 x 80 x 37 mm - EK-EF2-TP: 122 x 80 x 35 mm

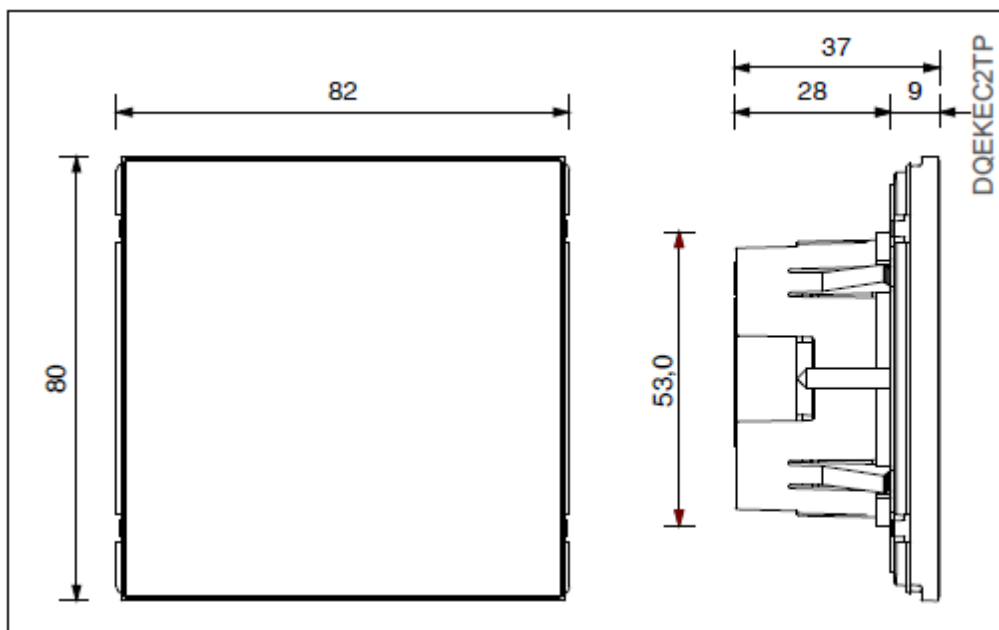

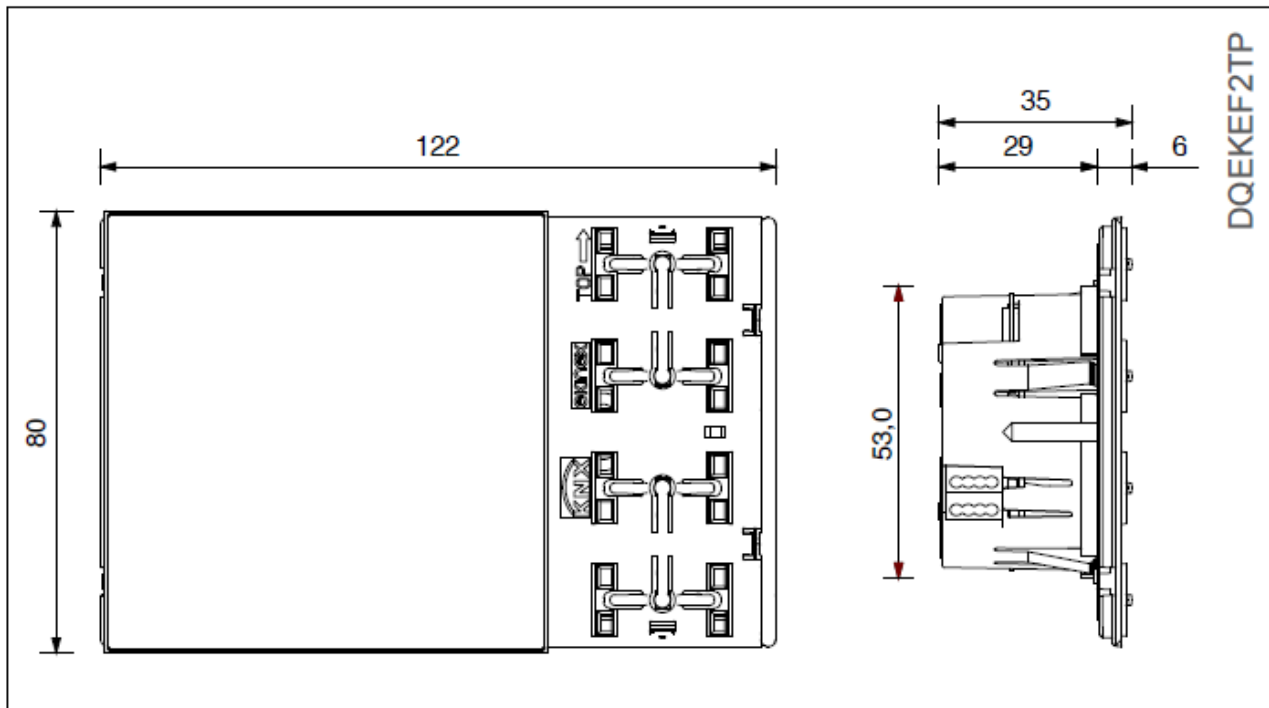

15.5 Warning

- Installation, electrical connection, configuration and commissioning of the device can only be carried out by qualified personnel.
- Opening the housing of the device causes the immediate end of the warranty period.
- ekinex® KNX defective devices must be returned to the manufacturer at the following address:

EKINEX S.p.A. Via Novara 37, I-28010 Vaprio d'Agogna (NO) Italy.

15.6 Other information

- This application manual is aimed at installers, system integrators and planners
- For further information on the product, please contact the ekinex® technical support at the e-mail address: support@ekinex.com or visit the website www.ekinex.com
- KNX® and ETS® are registered trademarks of KNX Association cvba, Brussels

© EKINEX S.p.A. The company reserves the right to make changes to this documentation without notice.